

We support PV systems

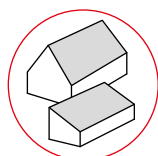

MOUNTING SYSTEMS

# Pitched roof





		Pantiles	Plain tile	Slate	Trapezoidal sheet metal	Sandwich panel	Corrugated sheet metal	Corrugated fibre cement	Standing seam roof
▶ SingleRail System	6	●	○	○	●	●	●	●	●
▶ SolidRail System	8	●	●	●	●	●	●	●	●
▶ Insertion System	10	●	○	○	●	●	●	●	○
▶ MiniRail System	12	○	○	○	●	●	○	○	○
▶ SpeedRail System	14	○	○	○	●	●	○	○	○
▶ MultiRail System	16	○	○	○	●	●	○	○	○
▶ MicroRail System	18	○	○	○	●	●	●	○	○
▶ S-Dome Small System	20	○	○	○	●	○	○	○	○
▶ Overview of roof fastenings	22								
▶ Accessories	26								
▶ Notes	34								

● Suitable      ○ Unsuitable

## Warranty

We offer a 12-year warranty on all K2 system components.  
[k2-systems.com/en/guarantee](http://k2-systems.com/en/guarantee)



## Statics and design loads

K2 mounting systems fulfil the calculation principles in accordance with Eurocode 1 and 9.

## Pallet delivery

Many mounting systems are delivered in pallets to save space and costs.

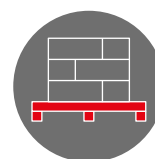

# K2 Digital Toolbox

Easy.  
Fast.  
**Safe.**



## WITH A FEW STEPS

Simply record the most important parameters on the smartphone with the K2 Check app. The data can be transferred seamlessly via a user account.

You can start planning directly with the key data in K2 Base. After your design, the data is transferred straight forwardly to the DocuApp. For the final documentation, many proofs are recorded, without any further work steps, and everything else is added shortly.

The K2 Digital Toolbox brings you many features, that make your everyday work easier and lead you quickly, easily and paperlessly to your goal.

CH

## K2 CHECK APP

- / **Roof Check:** Capture all data and important photos on the roof.
- / **Smart Pocket Funktion:** Access to all projects and Base reports including installation and ballasting plan.
- / **Systempreis:** Calculate reliable prices directly.
- / **Produktkatalog:** All assembly systems including technical documentation, videos and references.
- / Free download in Google Play and App Store.

[app.k2-systems.com](http://app.k2-systems.com) ↗



**K2 Base Feature: K2+ Interface** transfers all entered data to important other planning tools of the inverter manufacturers and to the yield calculation [e.g. from SolarEdge or SMA] with one click. This allows you to shorten your planning times with K2+ and as multiple data entry is no longer necessary.

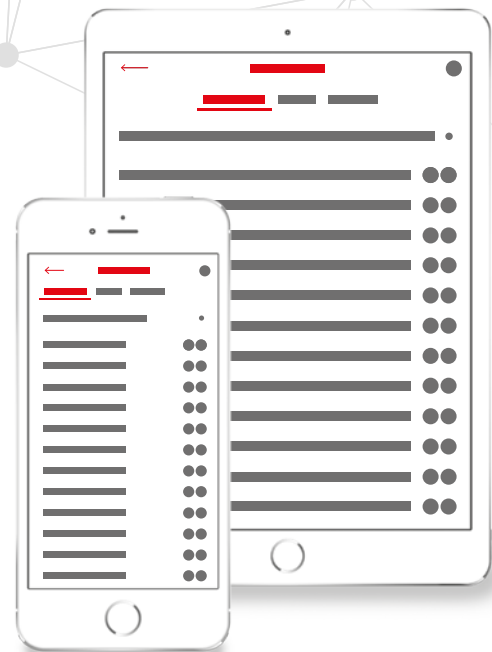

## BA K2 BASE

- / Free planning in 5 easy steps available in many languages.
- / Planning with Google Maps satellite images
- / Graphical drawing tools
- / Optimal static system design including verifiable statics
- / K2+: Simple transfer of project data for further calculation of electrical planning in inverter tools.

[base.k2-systems.com](http://base.k2-systems.com)

## DO K2 DOCU APP

- / Digital tool to automate project documentation project documentation.
- / Less paperwork and document everything clearly with an app.
- / Take down the attachment directly on your smartphone and have it signed.
- / Automatic dispatch of the project documentation after acceptance.

[docuapp.k2-systems.com](http://docuapp.k2-systems.com)

# SingleRail System

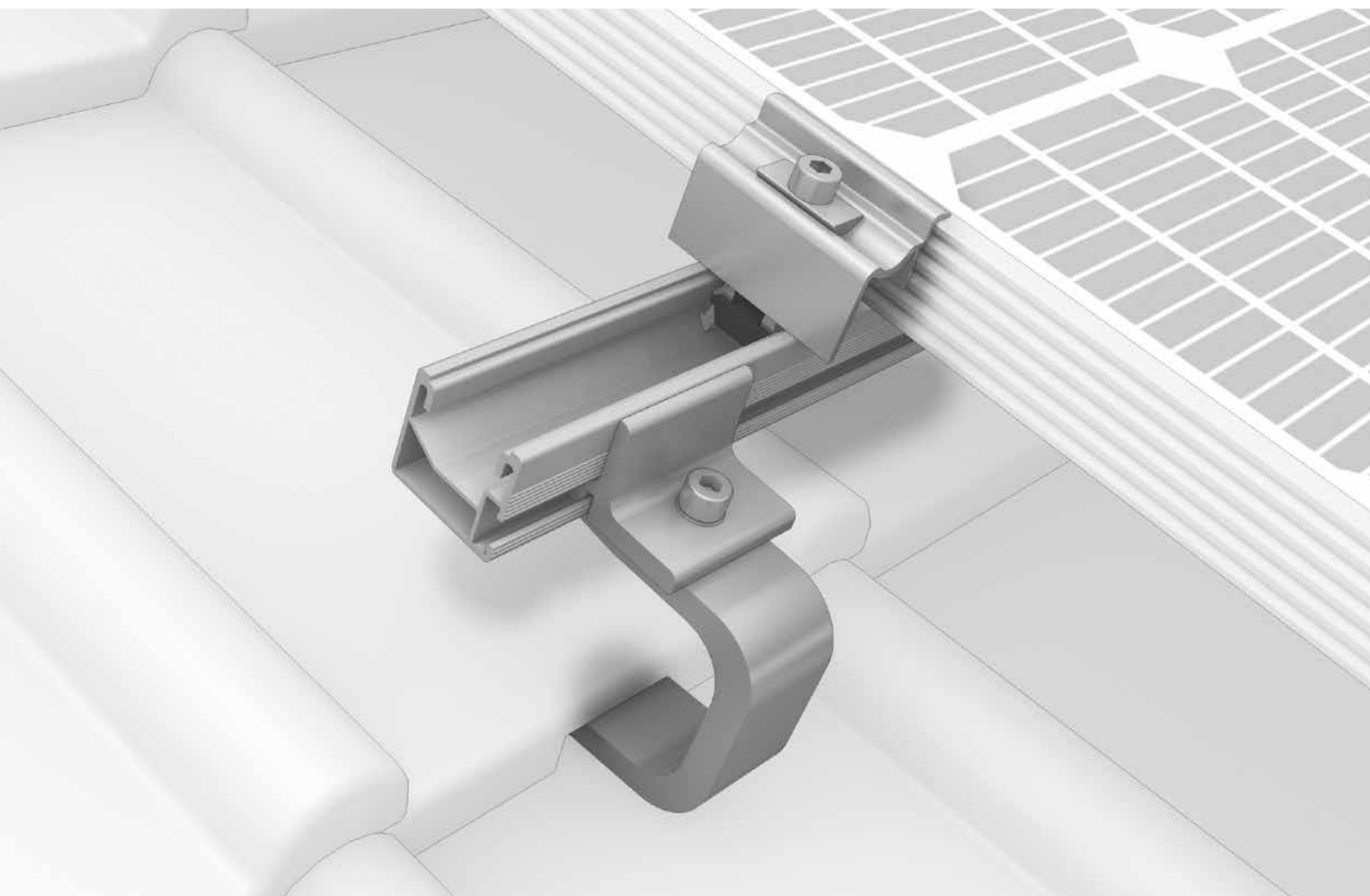

- / Quick and low-cost with direct lateral connections to the rail including customised height adjustment
- / Secure snap-in assembly - without needing to be screwed into the base plate
- / The SingleRail in combination with CrossHook roof hooks is very durable and versatile



## Roof fastenings

### Aluminium roof hooks

- / Optimum force transmission, can also be used on narrow rafters and direct connection to SingleRail
- / 80 % of all roof tiles and roofing stones covered
- / Simple height adjustment on base plate, extension arm or on slotted hole connection
- / CrossBoard/SingleBoard for rafter change
- / CrossHook 3S: With European construction approval ETA-16/0709



### Stainless steel roof hooks

- / High-quality, thin stainless steel outriggers and partly direct connection to SingleRail
- / For roof tiles, flat and pantiles
- / Height adjustable or many precisely fitting roof hooks with adapter connection from the SolidHook range

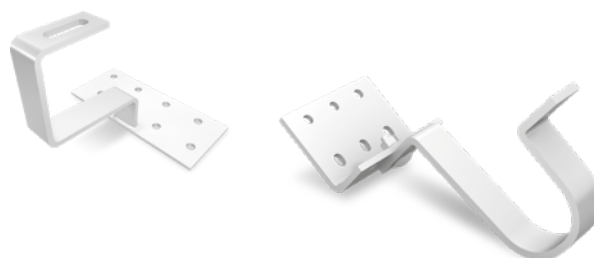

### Hanger bolts

- / For all corrugated fiber cement and corrugated sheet metal coverings with wooden substructure
- / Secure sealing at the roofing
- / With Climber connection
- / With German building authority approval [abZ]



### Sheet metal folding clamps

- / Many application possibilities: Double standing seam, angled seam, snap seam and round seam
- / Direct lateral rail connection
- / Penetration-free mounting

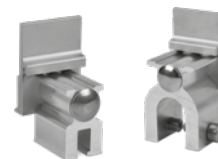

## Technical data

SingleRail	Light 36	36	50
<b>Figure</b>			
<b>Material</b>	Aluminium [EN AW-6063 T66]		
<b>W = width [mm]</b>	39.4	39.4	39
<b>H = height [mm]</b>	36	36	50
<b>Lengths [m]</b>	4.40	2.10 / 2.25 / 3.30 / 4.40 / 5.50	4.40
<b>Weight [kg/m]</b>	0.67	0.76	1.0
<b>Second rail layer</b>	SingleRail or SolidRail		

### Roof fastenings

You will find detailed technical data on our roof fastenings starting on page 22.

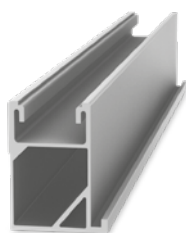
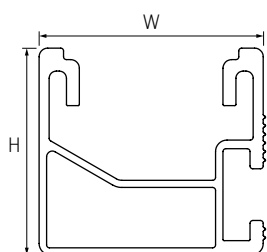

**SingleRail 63:** For heavy loads and large spans!

# SolidRail System

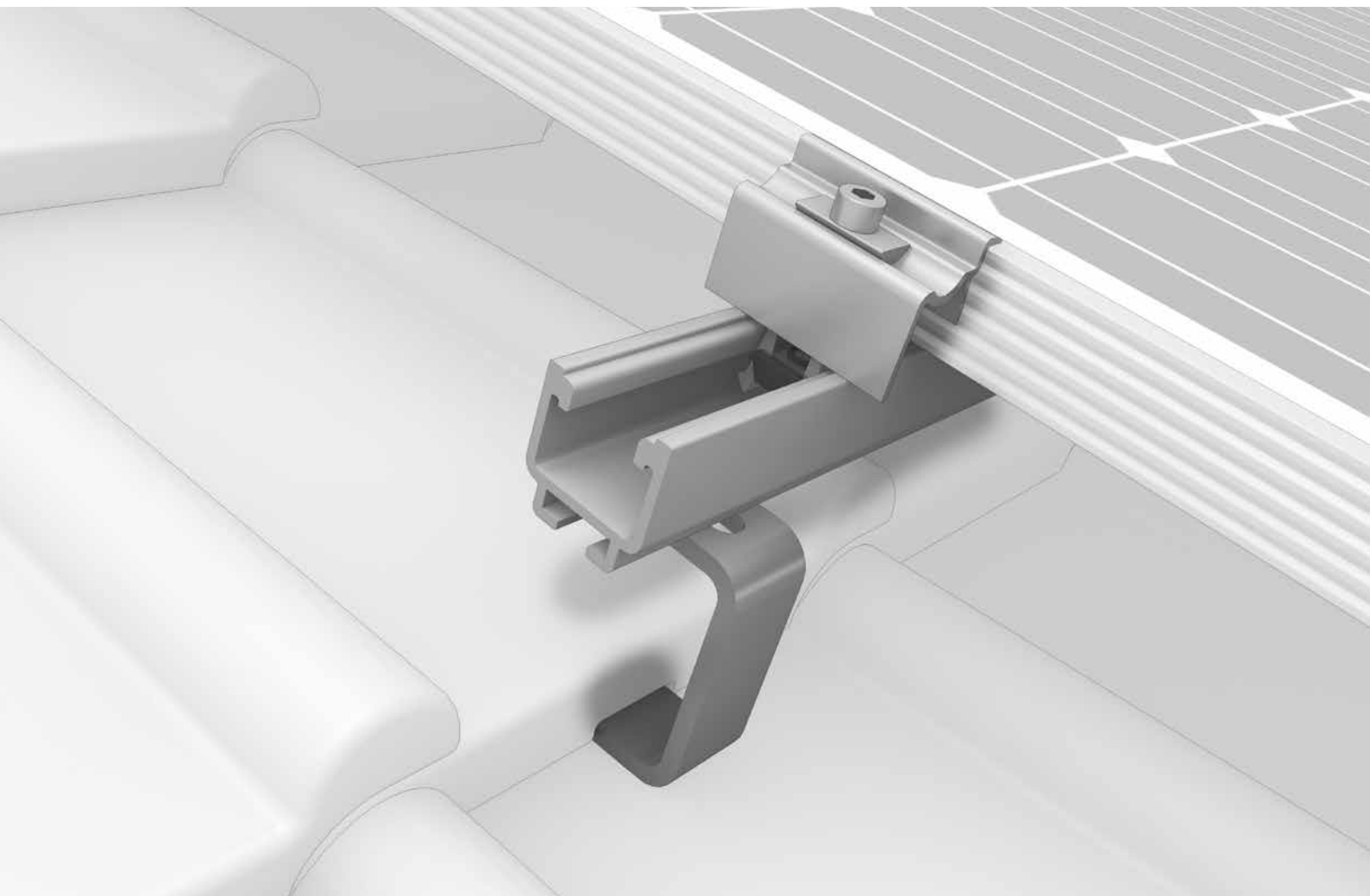

/ Comprehensive range of mounting rails for varying load profiles

/ Robust and structurally proven

/ High flexibility for a diverse range of widths





## Roof fastenings

### Stainless steel roof hooks

- / High-quality, thin stainless steel brackets with flexible adjustable connection even for narrow rafters
- / For pantiles, flat tiles and roof tiles
- / Height adjustable and many precisely fitting roof hooks

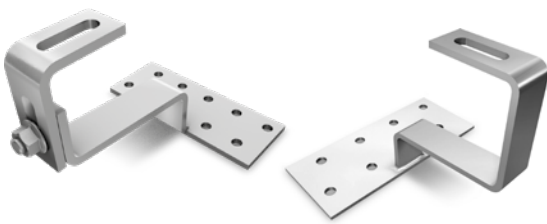

### Special roof hooks

- / Many application possibilities with the roof hooks for slate and beaver tail
- / Fastening on Coppo roofs is possible with the 1-fold height-adjustable SolidHook Coppo

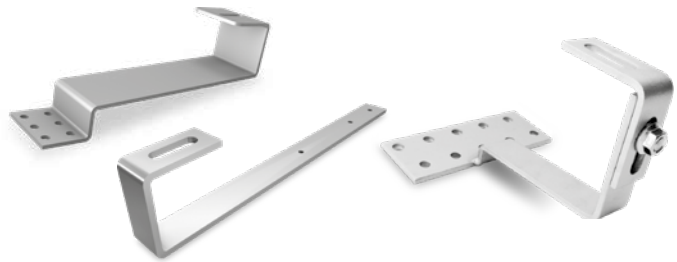

### Hanger bolts and solar fasteners

- / For all corrugated fiber cement, corrugated sheet metal and trapezoidal sheet metal coverings as well as sandwich panels
- / Secure sealing at the roofing
- / Connection via adapter plate with adjustment option
- / Hanger bolts with german building authority approval [abZ]



### Sheet metal folding clamps

- / Many application possibilities: Standing seam, angle seam, snap seam and round seam [e. g. Kalzip]
- / Rib-Roof solutions for 465, Speed 500 and Evolution
- / Penetration-free mounting



## Technical data

SolidRail	UltraLight 32	Light 37	Medium 42	Alpin 60
Figure				
Material	Aluminium [EN AW-6063 T66]			
W = width [mm]	39	39,5	41	41
H = height [mm]	32	37	42	60
Lengths [m]	2.10 / 2.25 / 3.30 / 4.40 / 5.50		4.40	5.50
Weight [kg/m]	0.7	0.85	1.3	1.7
Second rail layer	SingleRail or SolidRail			

### Roof fastenings

You will find detailed technical data on our roof fastenings starting on page 22.

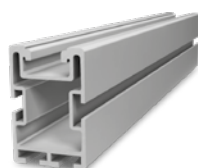
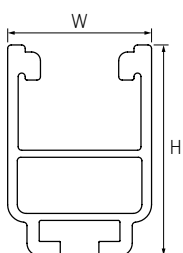
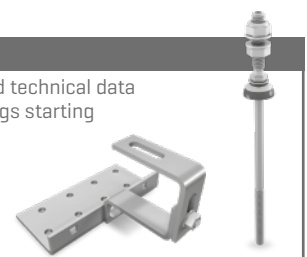

**SolidRail L:** For heavy loads across large widths!

# Insertion System

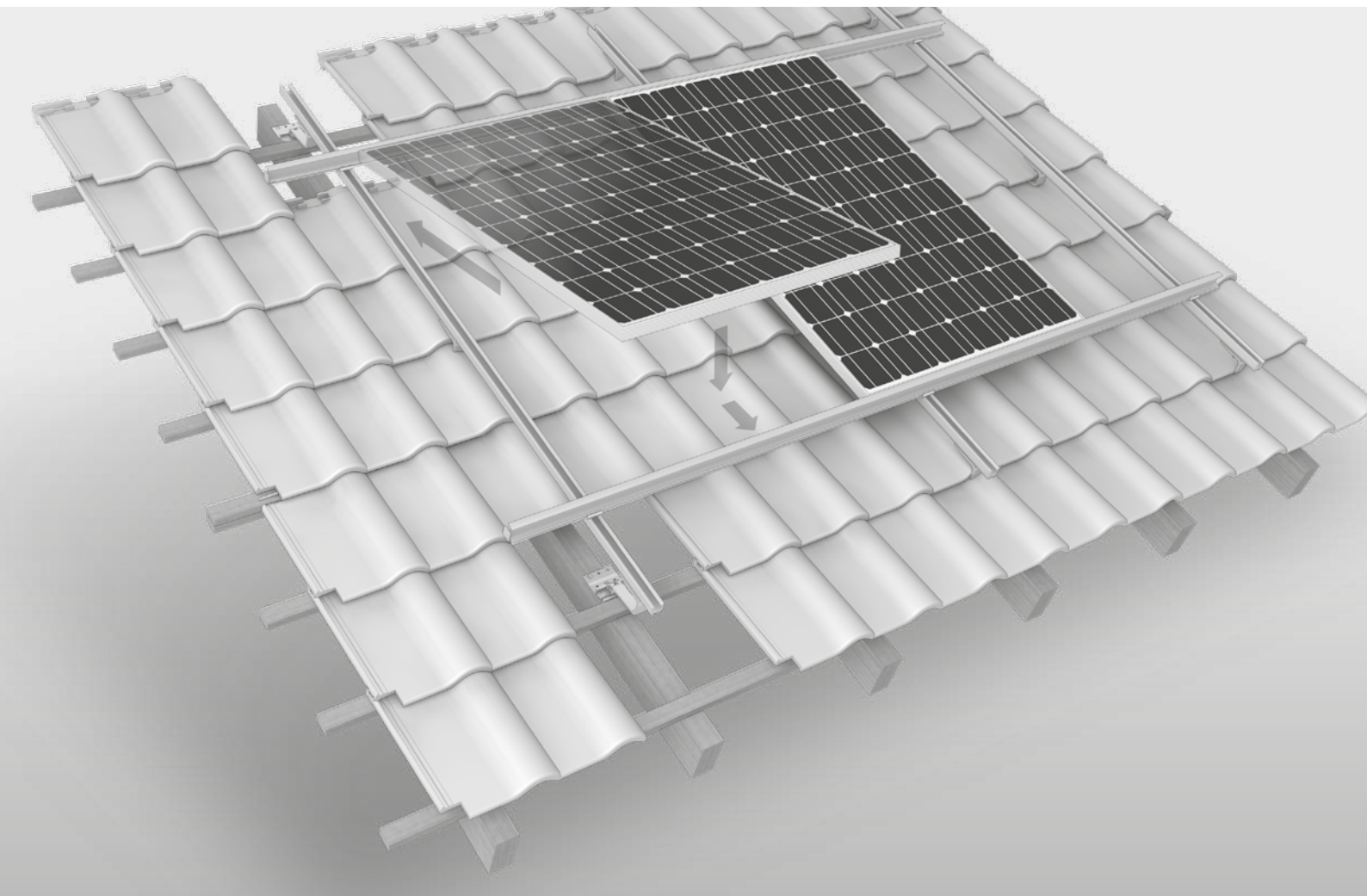

- / Without having to apply clamps eliminates the need for assistance ensuring lightning-fast installation
- / Easy to assemble with few components and without special tools
- / Sleek design with continuous closed surface adds further robustness
- / Insertion profile provides additional frame reinforcement



In cooperation with  
**solarteam** ● ●

## Components

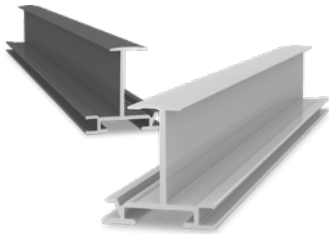

### Insertion rails

- / Intelligent solution for efficient module installation
- / Seals surface
- / Available in black



### Cross connector

- / Fixation for insertion rail on SolidRail
- / Simple mounting

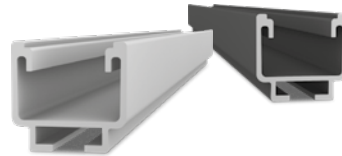

### SolidRail

- / Robust mounting rail
- / Different load conditions
- / For large spans
- / Available in black

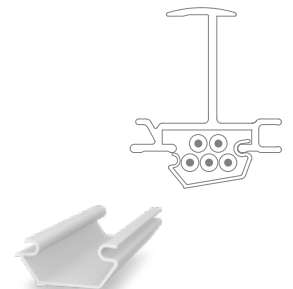

### Cable management

- / Quick cable connection beneath the insertion rail
- / Up to 5 cables

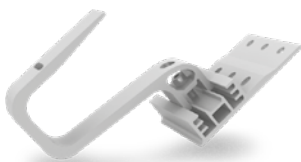

### CrossHook 3S+/4S+

- / Height-adjustable and laterally adjustable
- / Also suitable for narrow rafters



### Hanger bolts

- / For corrugated fibre cement or corrugated sheet roofing with wooden substructure
- / Custom height adjustment



### MultiRail

- / For trapezoidal sheet and sandwich panels
- / Roof attachment and supporting element

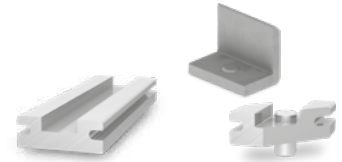

### Accessories

- / Connector insertion rail
- / Side stopper
- / Horizontal end bracket

## Technical data

	Insertion system
<b>Scope of application</b>	Pitched roofs with pan tiles, corrugated fibre cement, trapezoidal sheet or sandwich panels
<b>Fastening type / roof connection</b>	Roof hooks, hanger bolts or MultiRail
<b>Module frame heights [H]</b>	<ul style="list-style-type: none"> <li>• 30 mm</li> <li>• 35 mm</li> </ul>
<b>Requirements</b>	7 mm spacing between insertion rails
<b>Module orientation</b>	Landscape and portrait
<b>Material</b>	<ul style="list-style-type: none"> <li>• Mounting rails and cross connector: Aluminium EN AW-6063 T66</li> <li>• Components: stainless steel [1.4301] A2-70</li> </ul>
<b>SolidRail lengths [m]</b>	Aluminium mill finish: 4.30 and 5.40 Black anodised: 5.40
<b>Insertion rail lengths [m]</b> Aluminium mill finish / Black anodised	Insertion rail 30 5,40 m Insertion rail 35 5,40 m

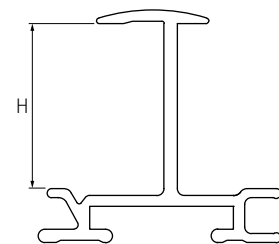

### Roof fastenings

You will find detailed technical data on our roof fastenings starting on page 22.

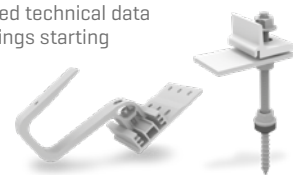

# MiniRail System

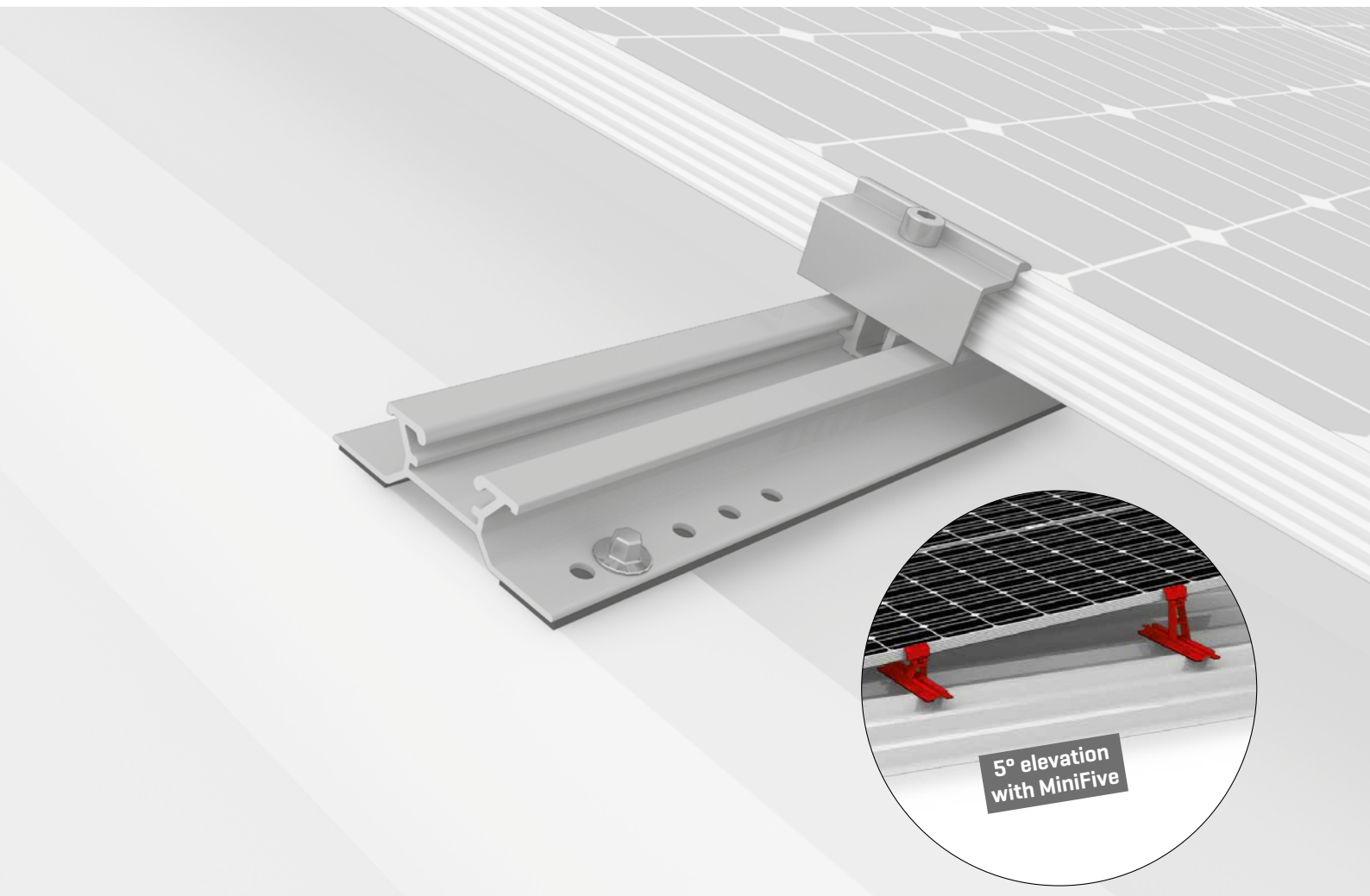

- / Innovative and statically optimised short rail system that is quick and easy to mount
- / Universal module clamps and suitable for portrait and landscape orientation
- / 5° elevation with MiniFive: significantly more output thanks to improved ventilation and optimised module angle
- / Optimised for storage and transport

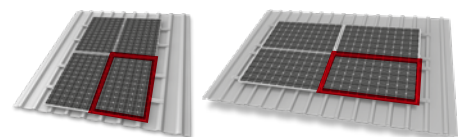
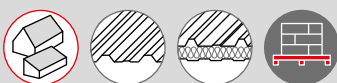

The MiniRail System allows portrait and landscape mounting in the form of grid mounting thanks to the universal module clamps, which are rotatable by 90°.

## Components

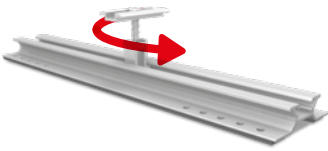

### MiniRail

- / Landscape and portrait mounting with MiniClamp MC/EC



### MiniClamp MC/EC 30 - 50 mm

- / Universal module clamp
- / Clamp is rotatable



### Self-tapping screws

- / Included in MiniRail MC/EC set
- / With sealing washers

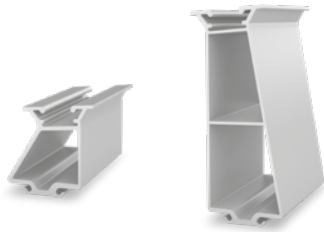

### MiniFive front and end

- / Single-sided, easy elevation with insertable supporting element
- / Improved ventilation and higher yield
- / Optimised module angle
- / Portrait and landscape mounting possible

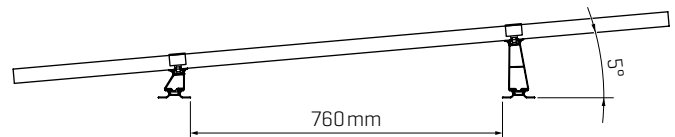

## Technical data

MiniRail System	
Scope of application	Pitched roofs with trapezoidal sheet metal or sandwich panels Roof inclination: 5 - 75°
Fastening type / roof fixture	Screws in roofing with self-tapping thin sheet screws
Requirements	<ul style="list-style-type: none"> <li>• Sheet thickness: <math>\geq 0.5</math> mm steel or aluminium</li> <li>• Sandwich panel: Approval from manufacturer required</li> <li>• Crest width: At least 22 mm *</li> <li>• Crest spacing: 101 - 350 mm depending on crest width</li> <li>• Flush area surrounding the bore hole: <math>\varnothing \geq 20</math> mm</li> <li>• Module frame height: 30 - 50 mm</li> </ul>
Module orientation	Vertical or horizontal
Material	Aluminium (EN AW-6063 T66 / EN AW-6082 T6); EPDM
Dimensions MiniRail W × H × L [mm]	78.2 × 23 × 385
Elevation with MiniFive	approx. 5°

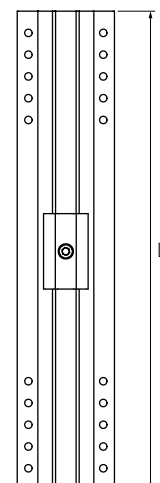
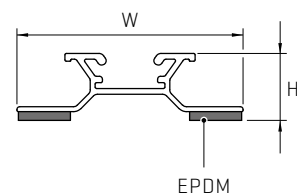

\* The project-specific minimum high crest width dimension can be found in the Base report.

# SpeedRail System

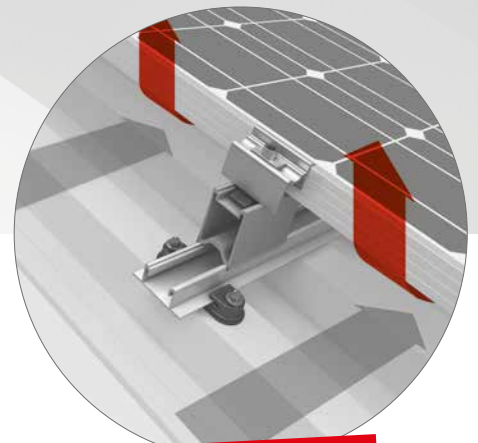
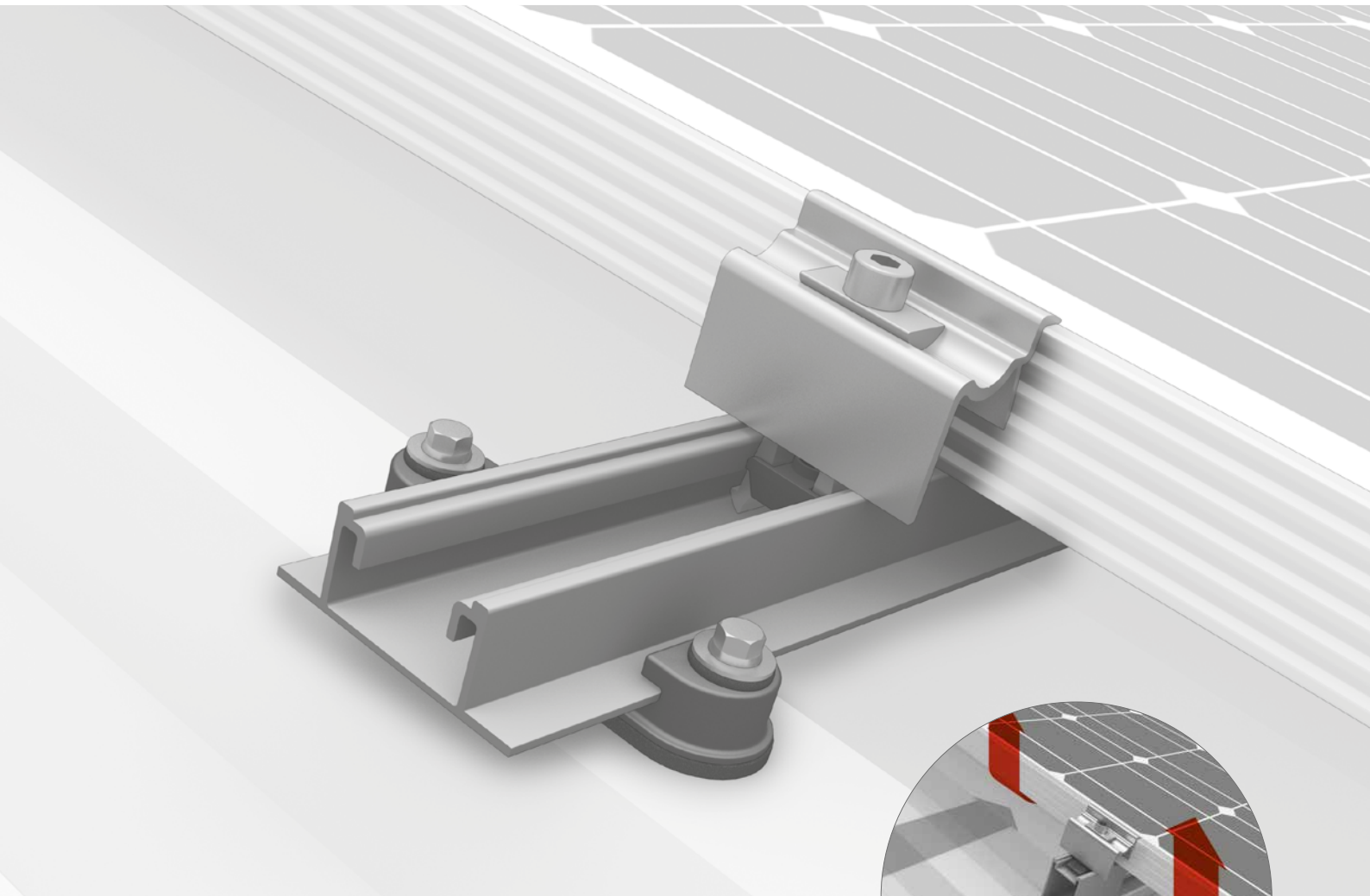

**Optionally with RailUp**

- / The proven long rail system for trapezoidal sheet applications as well as floating suspension with controlled thermal linear expansion
- / Our most popular system – over 3 GW installed worldwide
- / All-rounder with only 4 installation steps – also suitable for high loads



## Components

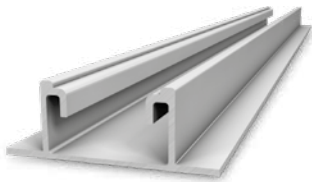

### SpeedRail

- / Mounting rail with easy insertion mounting into SpeedClips
- / Various lengths available



### SpeedClip

- / Mounting brackets for SpeedRail
- / Simple insertion feature
- / Glass fibre reinforced polyamide with EPDM seals
- / Fastened with self-drilling screws for trapezoidal sheet metal

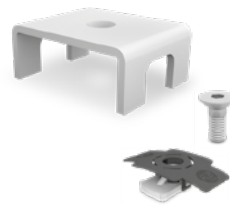

### SpeedLock

- / Mounting lock for SpeedRail in case of thermal expansion
- / In a set with MK2 slot nut and stainless steel screw



### SpeedConnector

- / Rail connector for SpeedRail
- / Three boreholes for flexible mounting
- / In a set with countersunk screws

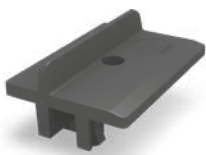

### AddOn

- / For grid mounting with horizontal modules
- / Seamless module blocks and no second rail layer

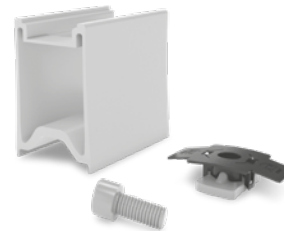

### RailUp Set

- / Improves rear ventilation of the modules
- / Easier installation of micro inverters

## Technical data

SpeedRail / SpeedClip	
<b>Scope of application</b>	Trapezoidal sheet roof
<b>Fastening type / roof fixture</b>	Insertion mounting into SpeedClips and screws in the roofing
<b>Requirements</b>	<ul style="list-style-type: none"> <li>▪ Sheet thickness: <math>\geq 0.4</math> mm steel or <math>\geq 0.5</math> mm aluminium</li> <li>▪ Sandwich panel: Approval from manufacturer required</li> <li>▪ Crest width: At least 22 mm</li> <li>▪ Flush area surrounding the bore hole: <math>\varnothing \geq 20</math> mm</li> </ul>
<b>Material</b>	<ul style="list-style-type: none"> <li>▪ SpeedRail: Aluminium [EN AW-6063 T66; 0.64 kg/m]</li> <li>▪ SpeedClip: Glass fibre reinforced polyamide with EPDM</li> </ul>
<b>SpeedRail dimensions</b>	
W = width [mm]	63
H = height [mm]	22.5
L = lengths [m]	2.25 / 3.30 / 4.40 / 5.50 m
<b>SpeedClip dimensions</b>	See drawing
<b>Second rail layer</b>	SingleRail or SolidRail

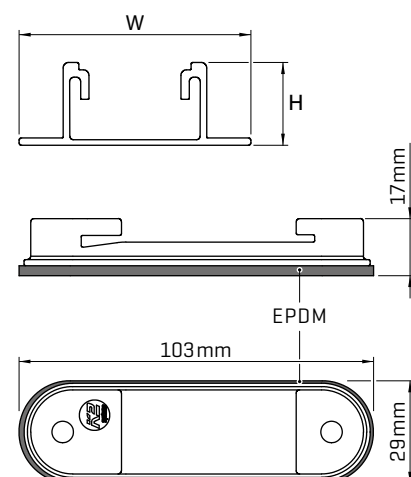

# MultiRail System

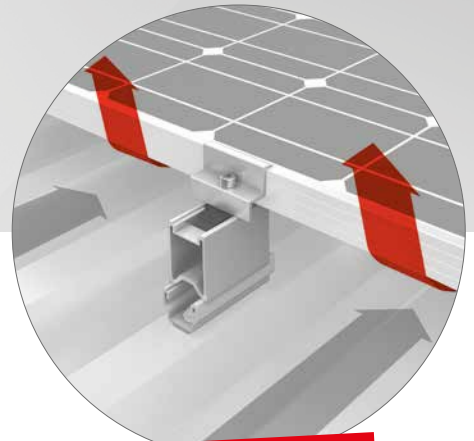
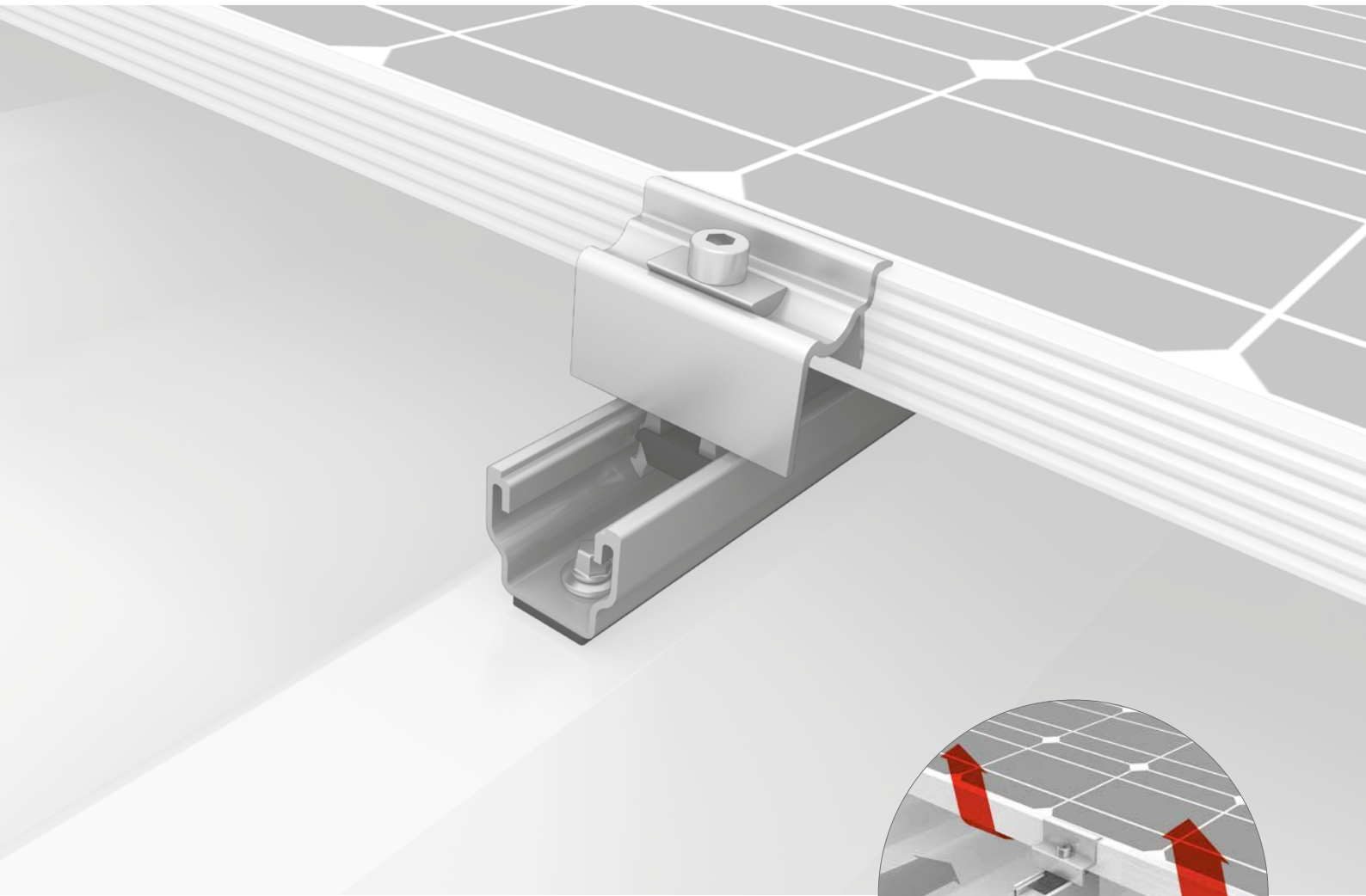

**Optionally with RailUp**

- / Easy and proven – as a short rail or a flexible component in various lengths
- / Quick planning with less material and greater effectiveness
- / Solid base rail for trapezoidal elevation S-Dome Small

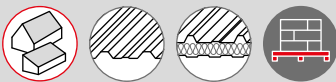



## Components



### Self-tapping screws

With sealing washers

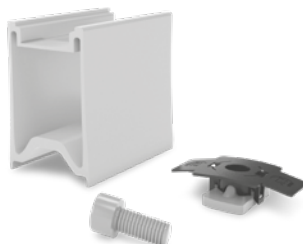

### RailUp Set

- / Improves rear ventilation
- / Easier installation of micro inverters

## MultiRail versions

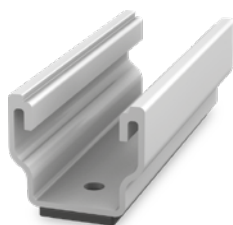

### MultiRail 10

- / Length 100 mm
- / Horizontal module orientation

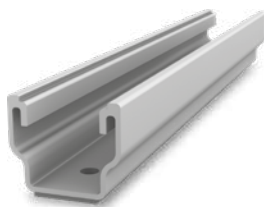

### MultiRail 25

- / Length 250 mm
- / For more flexibility and high load demands at horizontal module orientation

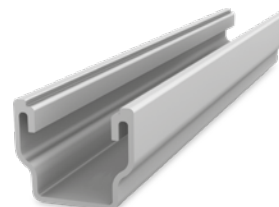

### MultiRail 4.20

- / Length 4200 mm
- / Long rail for cutting to customised sizes
- / Without EPDM seal; to be fastened manually with adhesive

## Technical data

	MultiRail 10, 25/4, 4.20
Scope of application	Pitched roofs, 5 - 75°, with trapezoidal sheet metal or sandwich panel
Fastening type / roof fixture	Fastened with self-tapping sheet screws
Requirements	<ul style="list-style-type: none"> <li>• Sheet thickness: <math>\geq 0.4</math> mm steel or <math>\geq 0.5</math> mm aluminium</li> <li>• Sandwich panel: approval from manufacturer required</li> <li>• Crest width: at least 22 mm</li> <li>• Maximum crest width: independent of crest distance</li> </ul>
Material	Aluminium [EN AW-6063 T66]; EPDM
W = width [mm]	39
H = height [mm]	35
L = rail length [mm]	<ul style="list-style-type: none"> <li>• MultiRail 10: 100</li> <li>• MultiRail 25/4: 250</li> <li>• MultiRail 4.20: 4200</li> </ul>
Second rail layer	SingleRail

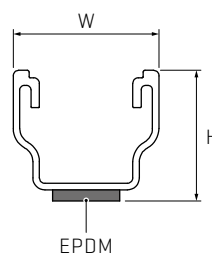

# MicroRail System

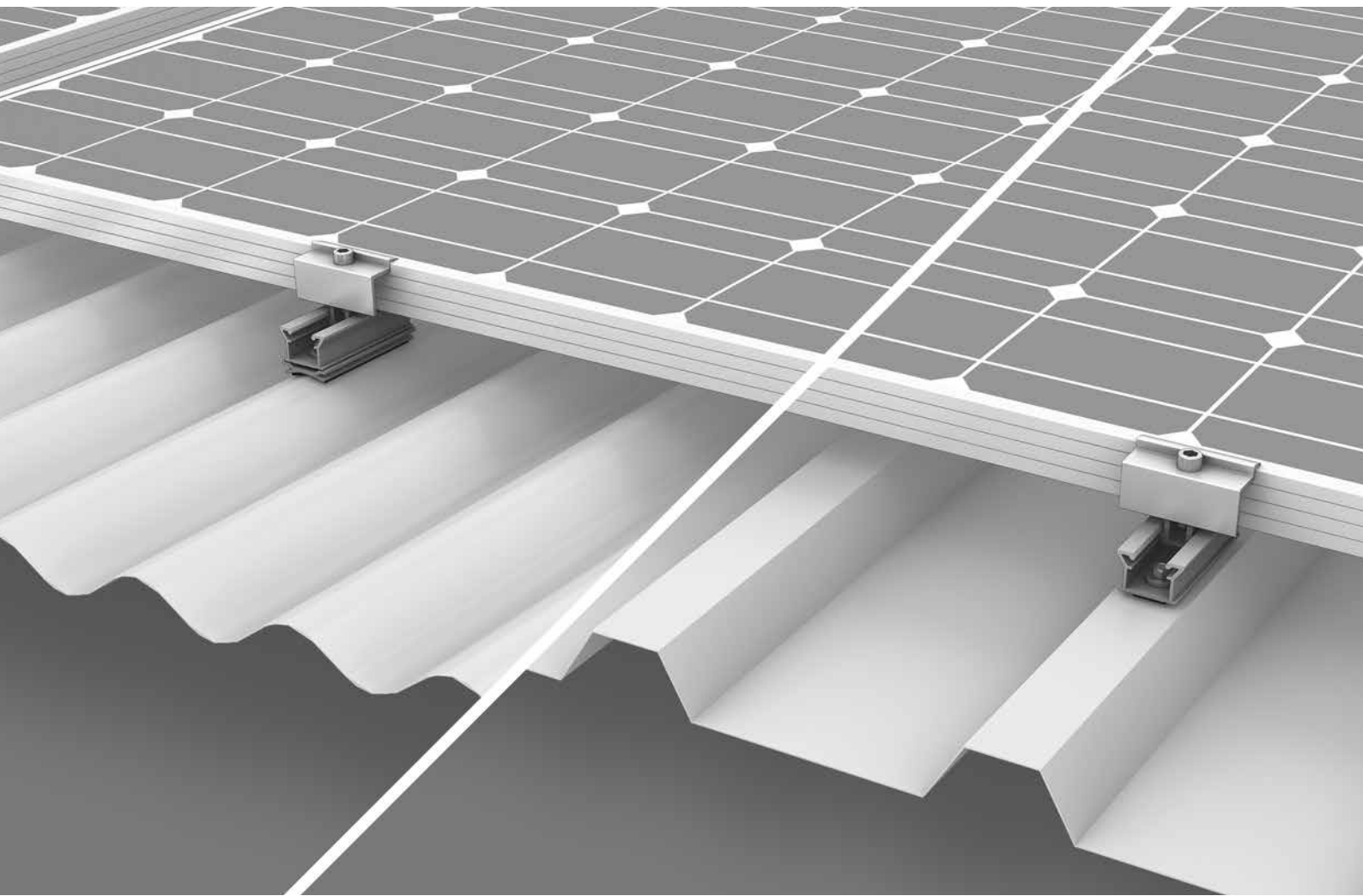

/ Fixes into sheet metal only, no need for fixings into substructure [e.g. purlins]

/ Quick and easy mounting on corrugated sheet metal using an adapter and directly on trapezoidal sheet metal

/ Only two rail lengths for all load cases

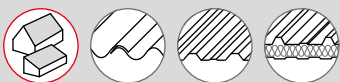

## Components



### MicroRail 10/25 CSM

- / Available as set with MicroRail and adapter
- / Corrugated sheet with radius 22-45mm

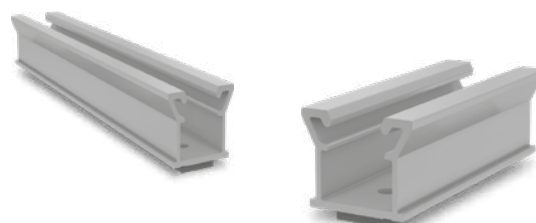

### MicroRail 10/25

For trapezoidal sheet metal or sandwich panel

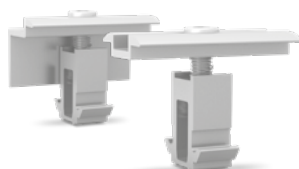

### MiniClamp MC/EC 30 - 50 mm

Universal module clamp



### Self-tapping screws

Self-sealing and thread forming

## Technical data

MicroRail System	
<b>Scope of application</b>	Pitched roofs with corrugated/trapezoidal sheet metal or sandwich panels Roof inclination: 5 - 75°
<b>Fastening type / roof fixture</b>	Screws in roofing with self-tapping thin sheet screws
<b>Requirements</b>	<ul style="list-style-type: none"> <li>▪ Sheet thickness: <math>\geq 0.4</math> mm steel or <math>\geq 0.5</math> mm aluminium</li> <li>▪ Sandwich panel: Approval from manufacturer required</li> <li>▪ Trapezoidal sheet crest width: <math>\geq 22</math> mm *</li> <li>▪ Trapezoidal sheet flush area surrounding bore hole: <math>\geq 20</math> mm</li> <li>▪ Corrugated sheet radiuses: 22-45mm</li> <li>▪ Module frame height: 30-50mm</li> </ul>
<b>Module orientation</b>	Horizontal / landscape
<b>Material</b>	Aluminium (EN AW-6063 T66 / EN AW-6082 T6); EPDM
<b>Dimensions W×H×L [mm]</b>	
▪ MicroRail 10/25	37×26×92/242
▪ MicroRail CSM	36×11×92

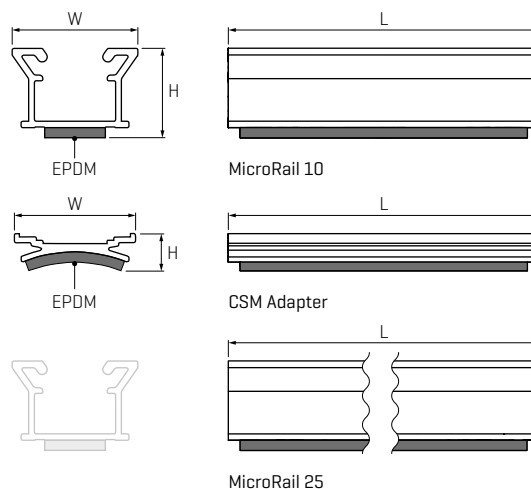

\* The project-specific minimum high crest width dimension can be found in the Base report.

# S-Dome Small System

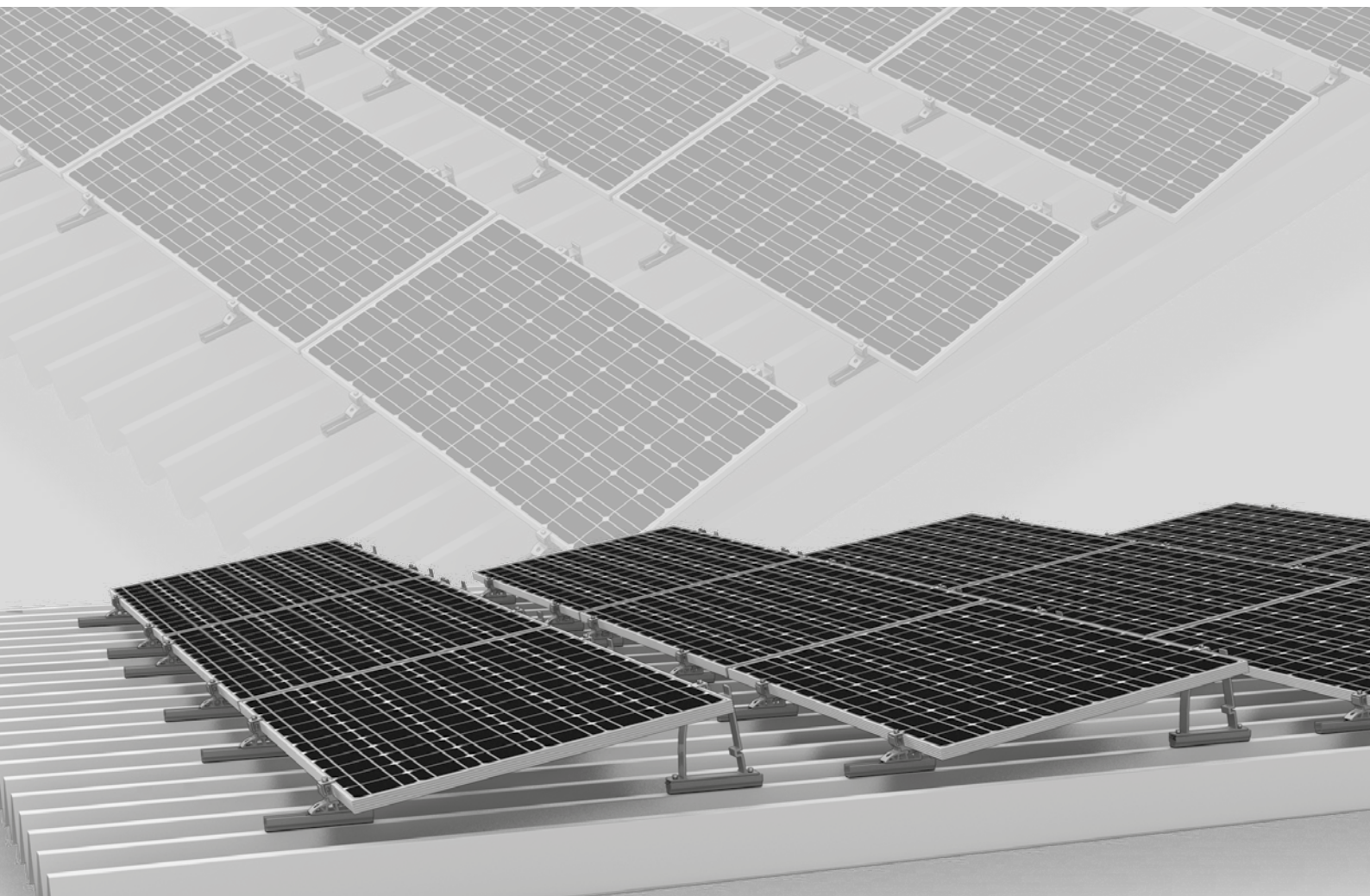

/ For a roof inclination of up to 15° on trapezoidal sheet metal

/ Economical in terms of materials and transportation; clever connections and strong holding power

/ The perfect combination of the all-round MultiRail component and load-optimised, slim 10° elevations



## Components



### Dome S1000 Small

Narrow elevation module support element



### Dome SD Small

Narrow module support element

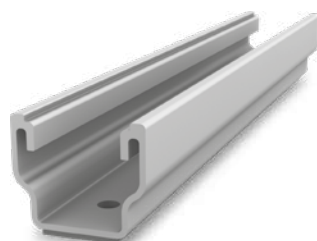

### MultiRail 25

- / Length 250 mm
- / With four boreholes for roofs with up to 15° inclination

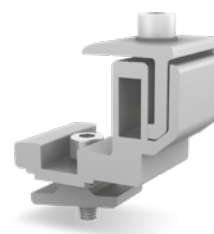

### FlexClamp Small

- / For clamping on the long side of module
- / Height adjustable





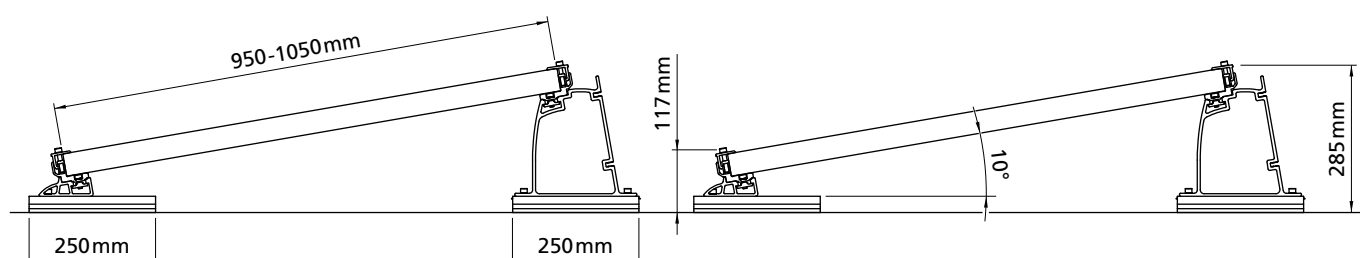

## Technical data

	S-Dome Small
<b>Scope of application</b>	Flat or pitched roofs $\leq 15^\circ$ with trapezoidal sheet metal roofing
<b>Fastening type / roof fixture</b>	Attached with drilling screws in trapezoidal sheets, parallel to raised crests
<b>Requirements</b>	<ul style="list-style-type: none"> <li>• Sheet thickness: <math>\geq 0.4</math> mm steel or <math>\geq 0.5</math> mm aluminium</li> <li>• Tensile strength for aluminium: 165 N/mm<sup>2</sup></li> <li>• Tensile strength for steel: acc. to approval min. S235 in acc. with DIN EN 10025-1</li> <li>• Crest width: min. 22 mm</li> <li>• Crest spacing: independent of crest distance</li> </ul>
<b>Inclination angle</b>	10°
<b>Material</b>	<ul style="list-style-type: none"> <li>• Mounting rails, Dome SD Small, Dome S1000 Small, FlexClamp Small: Aluminium [EN AW-6063 T66/ EN AW-6082 T6]; EPDM</li> <li>• Small parts: Stainless steel [1.4301] A2</li> </ul>



# Overview of roof fastenings

## Roof hooks for SingleRail

Type / image	Material	Base plate width [W]	Height under bracket [H <sub>1</sub> ] Bracket height [H <sub>2</sub> ] Total height [H <sub>3</sub> ]	Bracket depth [D]	Item no.
<b>CrossHook 3S Set</b> 	Aluminium	100 mm	<ul style="list-style-type: none"> <li>40/47/54 mm</li> <li>56 mm</li> <li>Approx. 123/130/137 mm</li> </ul>	83 mm	2003215
<b>CrossHook 4S Set</b> 	Aluminium	100 mm	<ul style="list-style-type: none"> <li>40/47/54 mm</li> <li>55 - 85 mm</li> <li>120,5 - 165 mm</li> </ul>	83 mm	2003144
<b>SingleHook 1.1*</b> 	Aluminium	100 mm	<ul style="list-style-type: none"> <li>47,1 mm</li> <li>56 mm</li> <li>162,9 mm</li> </ul>	83 mm	2001928
<b>SingleHook Alpin</b> 	Aluminium	100 mm	<ul style="list-style-type: none"> <li>35 mm</li> <li>60 mm</li> <li>169 mm</li> </ul>	110 mm	2003155
<b>CrossBoard for CrossHook 3S/4S and SingleBoard for SingleHook 1.1</b> 	Aluminium	2100 mm	See CrossHook 3S/4S respectively SingleHook 1.1!		2001972 / 2002935
<b>CrossHook 2 (BS EN 490)</b> 	Aluminium	150 mm	<ul style="list-style-type: none"> <li>44 mm</li> <li>46 mm</li> <li>100 mm</li> </ul>	116 mm	2003175
<b>SingleHook Vario*</b> 	Stainless steel	100 mm	<ul style="list-style-type: none"> <li>45 - 65 mm</li> <li>68 mm</li> <li>172 - 192 mm</li> </ul>	110 mm	2002651

Dimension drawing for CrossHook

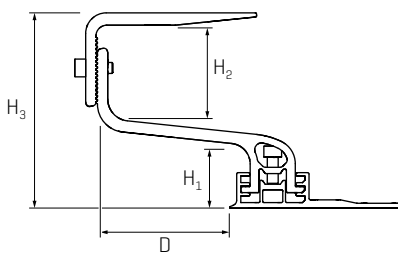

Dimension drawing for SingleHook

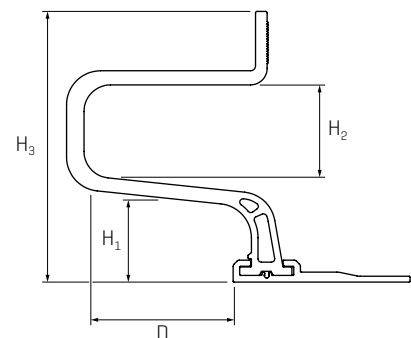

\* Suitable exclusively for SingleRail

## Roof hooks for SolidRail

Type /Figure	Base plate [a x b x c]	Bracket [d x e]	Bracket [H <sub>1</sub> ]/[H <sub>2</sub> ]	Total height approx. [H <sub>3</sub> ]	Bracket depth [D]	Item no.
<b>CrossHook 3S+/4+<sup>*1</sup></b> 	100 x 124 x 3,5 - 6,0 mm	35 x 8,5 mm	<ul style="list-style-type: none"> <li>3S+: 40/47/54 mm / 56 mm</li> <li>4S+: 40/47/54 mm / 55 - 85 mm</li> </ul>	<ul style="list-style-type: none"> <li>3S+: Approx. 123/130/137 mm</li> <li>4S+: 120,5 - 165 mm</li> </ul>	83 mm	2002390 / 2002402
<b>Pan tile<sup>*2</sup></b> 	150 x 60 x 5 mm	30 x 6 mm	47/65 mm	134 mm	98 mm	1000001
	180 x 80 x 4 mm	35 x 6 mm	38/69 mm	124 mm	91 mm	1000096
	180 x 80 x 4 mm	35 x 6 mm	47/68 mm	138 mm	124 mm	1001508
	180 x 80 x 5 mm	40 x 8 mm	47/55 mm	121 mm	87 mm	1000764
<b>Vario 1<sup>*2</sup></b> 	150 x 60 x 5 mm	30 x 6 mm	43 / 41 - 71 mm	112 - 145 mm	95 mm	1000125
<b>Vario 2<sup>*2</sup></b> 	140 x 55 x 5 mm	30 x 6 mm	49 - 58 / 57 - 76 mm	128 - 156 mm	94 mm	1000107
<b>Plain tile, double roofing<sup>*3</sup></b> 	75 x 52 x 4 mm	75 x 4 mm	34/62 mm	119 mm	234 mm	2003073
<b>Slate roofing<sup>*2</sup></b> 	40 x 250 mm	40 x 65 mm	-/60 mm	72 mm	72 mm	1000373
<b>Coppo<sup>*2</sup></b> 	150 x 60 x 5 mm	30 x 5 mm	18 / 88 - 118 mm	123 - 153 mm	120 mm	1001068

\*1 Material: Aluminium · \*2 Material: Stainless steel · \*3 Material: Magnelis 1.0242 (S250GD+ZM310)

### Dimension drawing

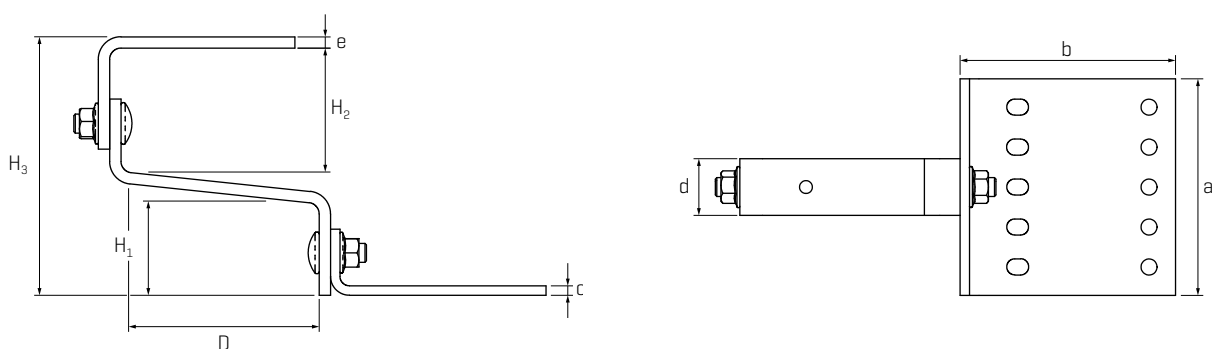

# Overview of roof fastenings

## Hanger bolts

### For timber substructures

For fastening the K2 SolidRail and SingleRail mounting rails on roofs with corrugated fibre cement or sheet metal on timber substructures. The K2 hanger bolts are equipped with an extra-long metric thread for installation height adjustment. Hanger bolts are outfitted with a pre-mounted adapter plate.

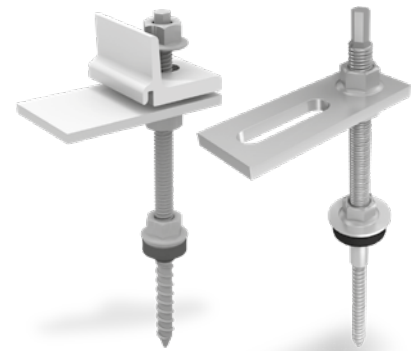

### SingleRail Hanger Bolts

Type	Item number
M10×180, hexagonal SW 7 mm	2003272
M10×200, hexagonal SW 7 mm	2003273
M10×250, hexagonal SW 7 mm	2003274
M12×200, hexagonal SW 9 mm	2003275
M12×250, hexagonal SW 9 mm	2003276
M12×300, hexagonal SW 9 mm	2003277

### SolidRail Hanger Bolt

Type	Item number
M10×180, hexagonal SW 7 mm	2000120
M10×200, hexagonal SW 7 mm	2000121
M10×250, hexagonal SW 7 mm	2000122
M12×200, hexagonal SW 9 mm	2000123
M12×250, hexagonal SW 9 mm	2000124
M12×300, hexagonal SW 9 mm	2000125

## Solar fastener

### For steel, timber and concrete substructures

Solar fasteners (stainless steel) for attaching the K2 SolidRail or SingleRail on roofs with trapezoidal sheet metal, corrugated fibre cement or corrugated sheet metal. Matching M10/M12 adapter plates are available separately.



**Steel:** Solar fastener Ø 8.0 with M10x50 metric top thread, E16 dome

Type	Item number
8×85 / 50, length 135 mm	2003018
8×115 / 50, length 165 mm	2003019
8×155 / 50, length 205 mm	2003020
8×195 / 50, length 245 mm	2003021



**Steel:** Solar fastener Ø 8.0 with M10x50 metric top thread, FZD

Type	Item number
8×85 / 50, length 135 mm	2003013
8×115 / 50, length 165 mm	2003012
8×155 / 50, length 205 mm	2003016
8×195 / 50, length 245 mm	2003017



**Wood:** Solar fastener Ø 8.0, M10 × 70 on request. With building authority approval [Z-14.4-532]. Material: A2 stainless steel, E16 calotte

Type	Item number
8×100 / 50, length 150 mm	1001770
8×130 / 50, length 180 mm	1001511
8×150 / 50, length 200 mm	1000807
8×180 / 50, length 230 mm	1001627
8×200 / 50, length 250 mm	1002749
8×80 / 50, length 130 mm	1002228



**Wood:** Solar fastener Ø 8.0, M10 × 70 on request. With building authority approval [Z-14.4-532]. Material: A2 stainless steel, with fibre cement seal.

Type	Item number
8×80 / 50, length 130 mm	1002130
8×100 / 50, length 150 mm	1003029
8×130 / 50, length 180 mm	1001759
8×150 / 50, length 200 mm	1002001
8×180 / 50, length 230 mm	1002533





## Standing seam and system clamps



Type / image	Standing seam type / roofing system	Opening dimension [mm]	Mounting rail	Material	Item no.
<b>Single Standing SeamClamp CF:x</b> 	Double-fold standing seam 	7,0	SingleRail	Aluminium	2003024
<b>Single Round SeamClamp CF:x</b> 	Round standing seam 	25,0	SingleRail	Aluminium	2002859
<b>Single Snap SeamClamp CF:x</b> 	Angeled and snap-lock standing seam 	14,0	SingleRail	Aluminium	2003083
<b>S-5! E-Mini-FL Standing SeamClamp</b> 	Double-fold standing seam 	7,0	SolidRail	Aluminium	1001052
<b>S-5! Z-Mini-FL Round SeamClamp</b> 	Round standing seam 	22,0	SolidRail	Aluminium	1000888
<b>Solid Snap SeamClamp CF:x</b> 	Angeled and snap-lock standing seam 	14,0	SolidRail	Aluminium	2003082
<b>Solid Standing SeamClamp</b> 	Double-fold standing seam 	3,5	SolidRail	Stainless steel	2001712
<b>Solid Round SeamClamp</b> 	Kalzip roofings with round seam 	10,5	SolidRail	Stainless steel	2001853
<b>Rib-Roof Evolution Clamp</b> 	Rib-Roof Evolution 	23,0	SolidRail	Aluminium	2002226
<b>Rib-Roof Speed 500 Clamp</b> 	Rib-Roof Speed 500 	17,0	SolidRail	Aluminium	2002225
<b>Rib-Roof 465 Clamp</b> 	Rib-Roof 465 trapezoidal profile 	12,0	SolidRail	Aluminium	2002118
<b>RibClamp KL</b> 	Klip-Lok classic 700 Klip-Lok 406 Klip-Tite 700 	20,0	SolidRail or MiniClamp without basic rail	Aluminium	2002857

# Accessories

▶ Module clamps	27
▶ Self-drilling wood screw, flange head	28
▶ Thread-forming tapping screw with EPDM supported washer	29
▶ T-bolt and flange nuts with serration	29
▶ MK2 slot nuts with assembly clip	29
▶ Self-drilling wood screw, flange head, underhead secondary thread	30
▶ Self-drilling wood screw, countersunk head	30
▶ Screw anchor, Multi Monti	30
▶ Endcaps SingleRail 36	31
▶ Endcaps SolidRail	31
▶ Lightning protection clamp Multi Sets	31
▶ TerraGrif equipotential bonding	31
▶ Pad spacer	32
▶ Height Compensator for aluminium roof hooks	32
▶ L-Adapter SR Set	32
▶ Cable Manager	32
▶ CrossConnectors	33
▶ StairPlate Set	33
▶ RailUp Set	33

## Module clamps

The module clamps cover the most common module frame heights of 30 – 42 mm. Compatible with SingleRail, SpeedRail, MultiRail and SolidRail.

### Module middle clamps XS

Module frame height / description	Item number
OneMid, middle clamp, aluminium mill finish	2003071
OneMid, middle clamp, black anodised	2003072
OneEnd, end clamp, aluminium mill finish	2002514
OneEnd, end clamp, black anodised	2002589

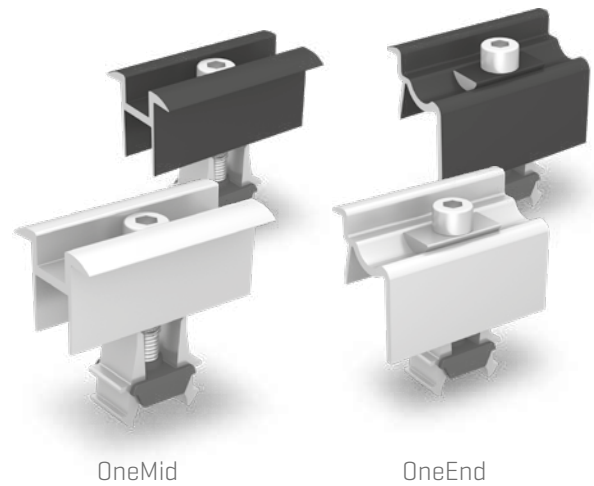

### Module middle clamps XS

Module frame height / description	Item number
30 - 33 mm / M8×50, aluminium mill finish	1005156
30 - 33 mm / M8×50, black anodised	1005157
39 - 44 mm / M8×60, aluminium mill finish	1004908
39 - 44 mm / M8×60, black anodised	1005159
45 - 48 mm / M8×65, aluminium mill finish	1005143
45 - 48 mm / M8×65, black anodised	1005160
49 - 50 mm / M8×70, black anodised	1004407
49 - 50 mm / M8×70, schwarz eloxiert	1005161

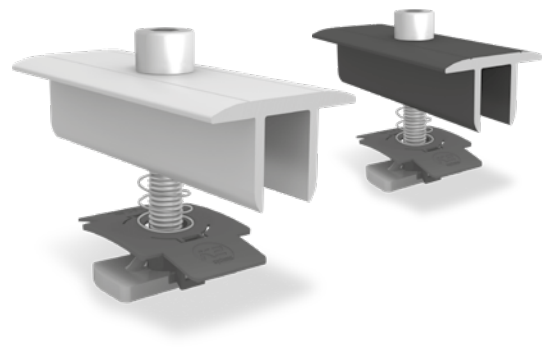

### Module end clamps

Module frame height / description	Item number
30 - 31 mm / M8×30, aluminium mill finish	1005345
30 - 31 mm / M8×30, black anodised	1005347
42 - 44 mm / M8×35, aluminium mill finish	1005291
42 - 44 mm / M8×35, black anodised	1005295
45 - 47 mm / M8×40, aluminium mill finish	1005171
45 - 47 mm / M8×40, black anodised	1005270
49 - 50 mm / M8×45, aluminium mill finish	1005172

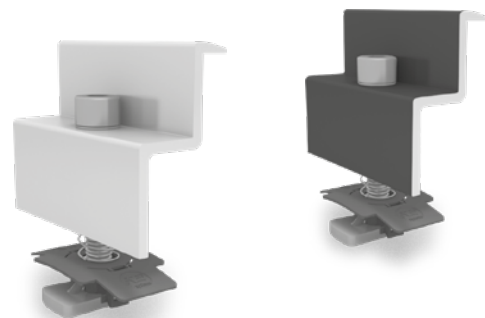

# Accessories

## Module clamps for laminate modules

Module middle clamps for fastening laminate modules; approved for First Solar and Calyxo thin-film modules; small module spacing.

Material: Aluminium mill finish, EPDM

Please note: For additional anti-slip protection the K2 Slideguard is suitable for vertical mounting of laminate modules with a glass thickness of 6-9 mm.

Material: Stainless steel 1.4016, EPDM



Type / accessory	Item number
Module middle clamp	1003157
Module end clamp	1003158
Slideguard	1005828

## Self-drilling wood screw, flange head

Self-drilling wood screw with flange head (Topix) and star socket (Torx) from Heco. With European Technical Assessment (ETA) approval. Material: Stainless steel A2, matches TX 25/40 screwdrivers

Type	Item number
6×80	2004106
6×100	2004107
8×80	2004111
8×100	2004112
8×120	2004113
8×160	2004115
8×180	2004116
8×200	2004117



## Thread-forming tapping screw with EPDM supported washer

Approved for steel sheets with a minimum thickness of 0.4 mm and aluminium sheets with a minimum thickness of 0.5 mm. Thin sheet screw, virtually chip-free, SW 8, sealing washer  $\varnothing$  16 mm.

Material: Stainless steel A2, EPDM

Type	Item number
6 x 25 mm	1005207
6 x 38 mm	1005193



## T-bolt and flange nuts with serration

T-bolt for use in the lower chamber of K2 SolidRail rails. Head form: 28/15; head dimensions: 22.5 x 10.5 x 4 mm  
Material: Stainless steel A2 1.4301

Type	Item number
M8x20/30	1000614/1000368
M10x20/30	1000637/1000041



The flanged nut with serration [similar to ISO 4161] prevents it from loosening.

Material: Stainless steel A2

Type	Item number
M8	1000043
M10	1000042

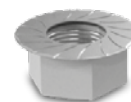

## MK2 slot nuts with assembly clip

The MK2 slot nuts can be used at any point on the K2 rails. They automatically lock in place. Subsequently, they can easily be moved about in the rail by pressing them lightly.

Material: Stainless steel 1.4301 + PA or aluminium + PA

Type	Item number
Stainless steel	1001643
Aluminium	2000034

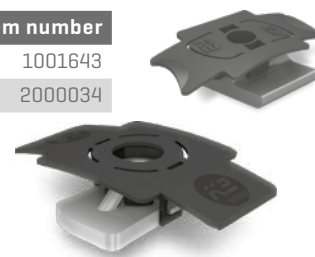

# Accessories

## Self-drilling wood screw, flange head, underhead secondary thread

Self-drilling wood screw [Heco] with flange head [Topix] and star socket [Torx]. With building approval. For mounting with over-rafter insulation. Fixes the counterbattens in place using a second screw thread under screw head. Material: Stainless steel A2; matches TX 40 screwdrivers  
Item number: 1003437



## Self-drilling wood screw, countersunk head

Self-drilling wood screw with countersunk head [Heco]. With building approval.  
Material: Stainless steel A2; matches TX 25 screwdrivers  
Item number: 2004108



## Screw anchor, Multi Monti

Multi Monti screw anchor [Heco] for fastening to concrete; min. borehole depth 40 mm. Steel surface: galvanised and blue passivated, head diameter 17 mm, nominal bore diameter 6 mm  
Material: Galvanised steel  
Drive: TX 30



Type	Item number
7,5 x 40 [TX 30]	2002570
10 x 70 [SW 13]	2002571

## Endcaps SingleRail 36

End caps for SingleRail 36.  
Material: Glass fibre reinforced polyamide  
Item number: 1004767



## Endcaps SolidRail

End caps for K2 SolidRail.  
Material: Glass fibre reinforced polyamide

Type	Item number
Light	1004765
Medium	1004766
Alpin	1005053

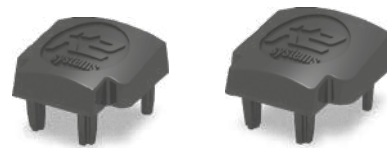

## Lightning protection clamp Multi Sets

Lightning protection clamp for clamping lightning protection cables with  $\varnothing$  8 mm.  
For universal use as a T, cross, parallel and impact clamps. Material: aluminium

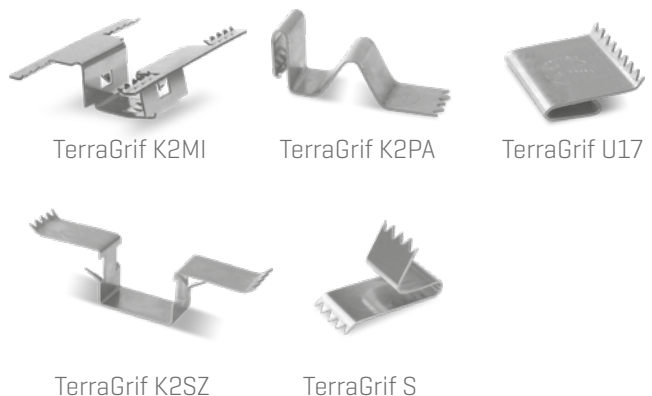

Image	Type	Components	Item number
	<b>Lightning protection clamp Multi Alu 8 mm Set</b>	<ul style="list-style-type: none"> <li>Lightning protection clamp Multi [1003151], aluminium</li> <li>Slot nut [1001643], stainless steel, PA</li> <li>Washer [8,4×20×1.2 mm], stainless steel A2</li> <li>Allen Bolt [M8×30], stainless steel A2</li> </ul>	2002473
	<b>Lightning protection clamp 8 mm Double Set</b>	<ul style="list-style-type: none"> <li>2× lightning protection clamps Multi [1003151], Aluminium</li> <li>Hexagon flange nut with serration M8 [100043]; stainless steel A2</li> <li>2× washers [8,4×20×1.2 mm], stainl. steel A2</li> <li>Allen Bolt [M8×40], stainless steel A2</li> </ul>	2002474

## TerraGrif equipotential bonding

Equipotential bonding between module and rail.  
Material: Stainless steel

Type	Item number
TerraGrif K2Mi Landscape/Portrait	2002649
TerraGrif K2PA 32 Landscape	2000055
TerraGrif U17 Portrait	2000056
TerraGrif K2SZ Landscape/Portrait	2001881
TerraGrif S	2002397



# Accessories

## Pad spacer

Shim to adjust height differences between rails and roof hooks of the K2 SingleHook and K2 CrossHook family. Any number of spacer shims can be stacked to provide customised height.

Material: Glass fibre reinforced PA, Material thickness: 2 mm

Item no.: 1002361



## Height Compensator for aluminium roof hooks

Shim to compensate for batten height differences and adjustment of height under bracket of the K2 SingleHook and K2 CrossHook family.

Material: Aluminium, Material thickness: 4 mm

Item no.: 2002332



## L-Adapter SR Set

Connection set to attach the SingleRail to SolidHooks.

Material: Aluminium + stainless steel

Item no.: 2002683

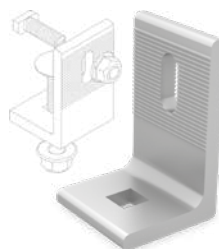

## Cable Manager

Solar Cable Manager with connecting possibility for outdoor-installation L x W: 200 x 4.6 mm

Item no.: 2002870

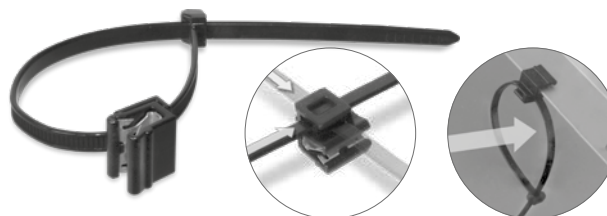

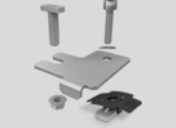

## CrossConnectors

Image	Type	Components	item number
	<b>SingleRail Climber 36/50 Set</b>	<ul style="list-style-type: none"> <li>▪ Suitable for K2 SingleRail Light, 36 &amp; 50</li> <li>▪ Screws and nuts included</li> <li>▪ Material: Aluminium EN AW-6063 T66, stainless steel A2</li> </ul>	2003145
	<b>SolidRail CrossConnector Set</b>	<ul style="list-style-type: none"> <li>▪ Set of components for a perpendicular connection of rails</li> <li>▪ Suitable for K2 SolidRail Light, Medium and Alpine.</li> <li>▪ Screws and nuts included</li> <li>▪ Material: Stainless steel and PA</li> </ul>	1004110

## StairPlate Set

With the K2 StairPlate Set, Micro Inverters and Optimizers from Solar Edge and Enphase can be hooked into all K2 rails [except K2 MiniRail and MicroRail] without bolting them directly to the roof. The units can be connected to the K2 StairPlate in advance with the screws and nuts included in the set and then flexibly moved in the mounting rail. The height of the modules and the units to be used must be taken into account.

Material: Stainless steel  
Item number: 2004057

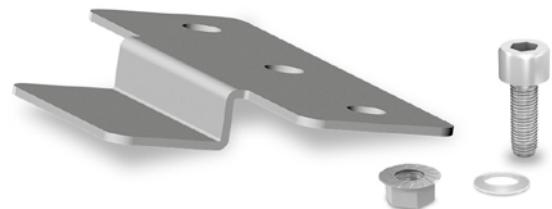

## RailUp Set

Add-on for the K2 SpeedRail and K2 MultiRail System. The RailUp Set enables the modules to sit raised by 60 mm with a minimum of material. This facilitates the installation of the Micro Inverters. In addition, an optimal module rear ventilation and a higher module output on the trapezoidal sheet metal roof is achieved. RailUp is supplied as a set and requires no additional material for installation.

Item number: 2003191

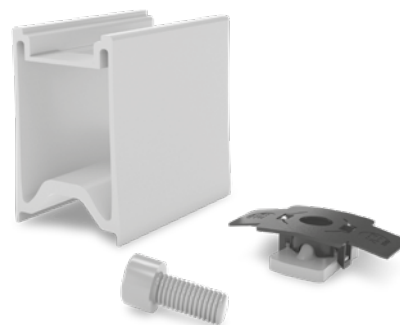

# Notes

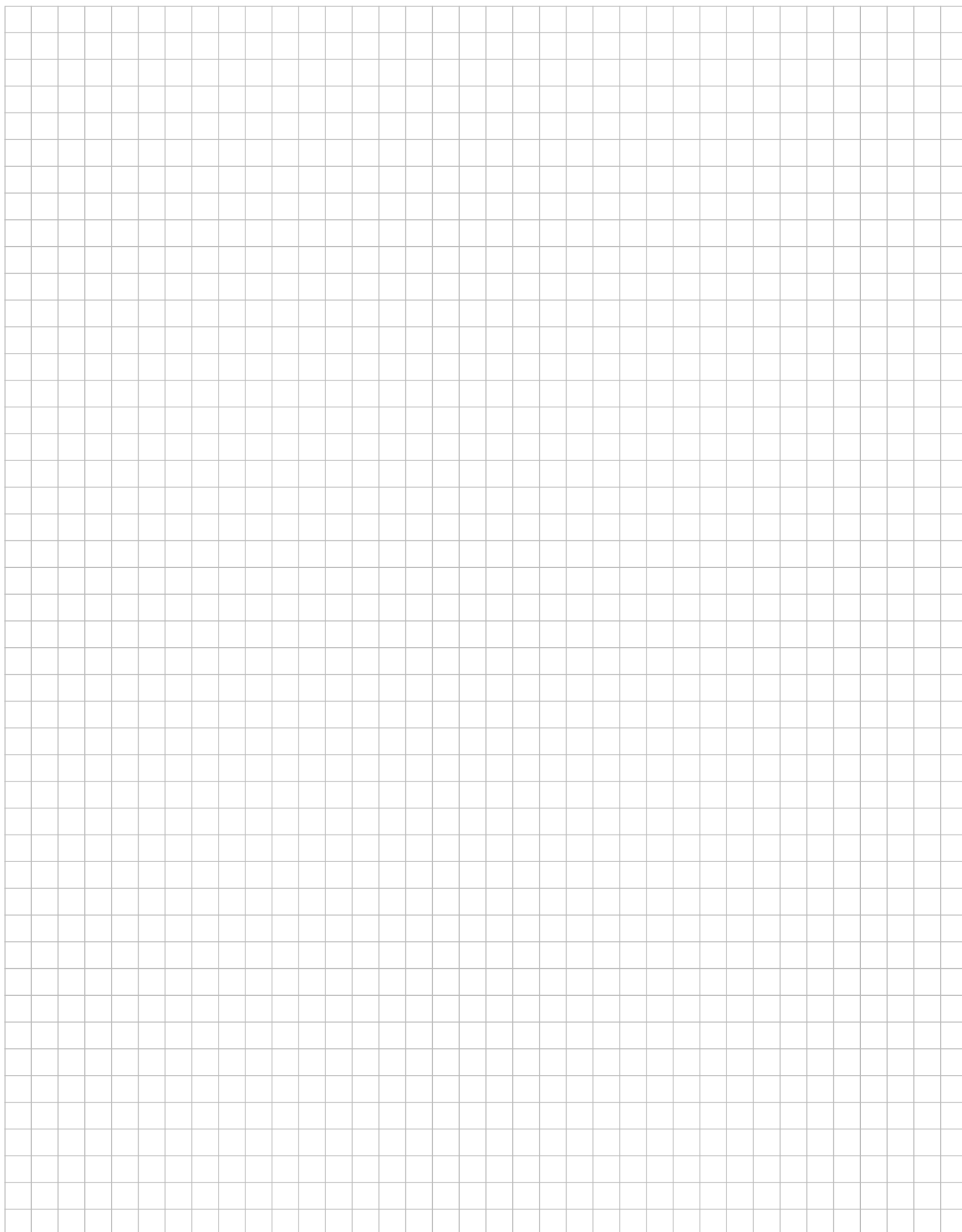

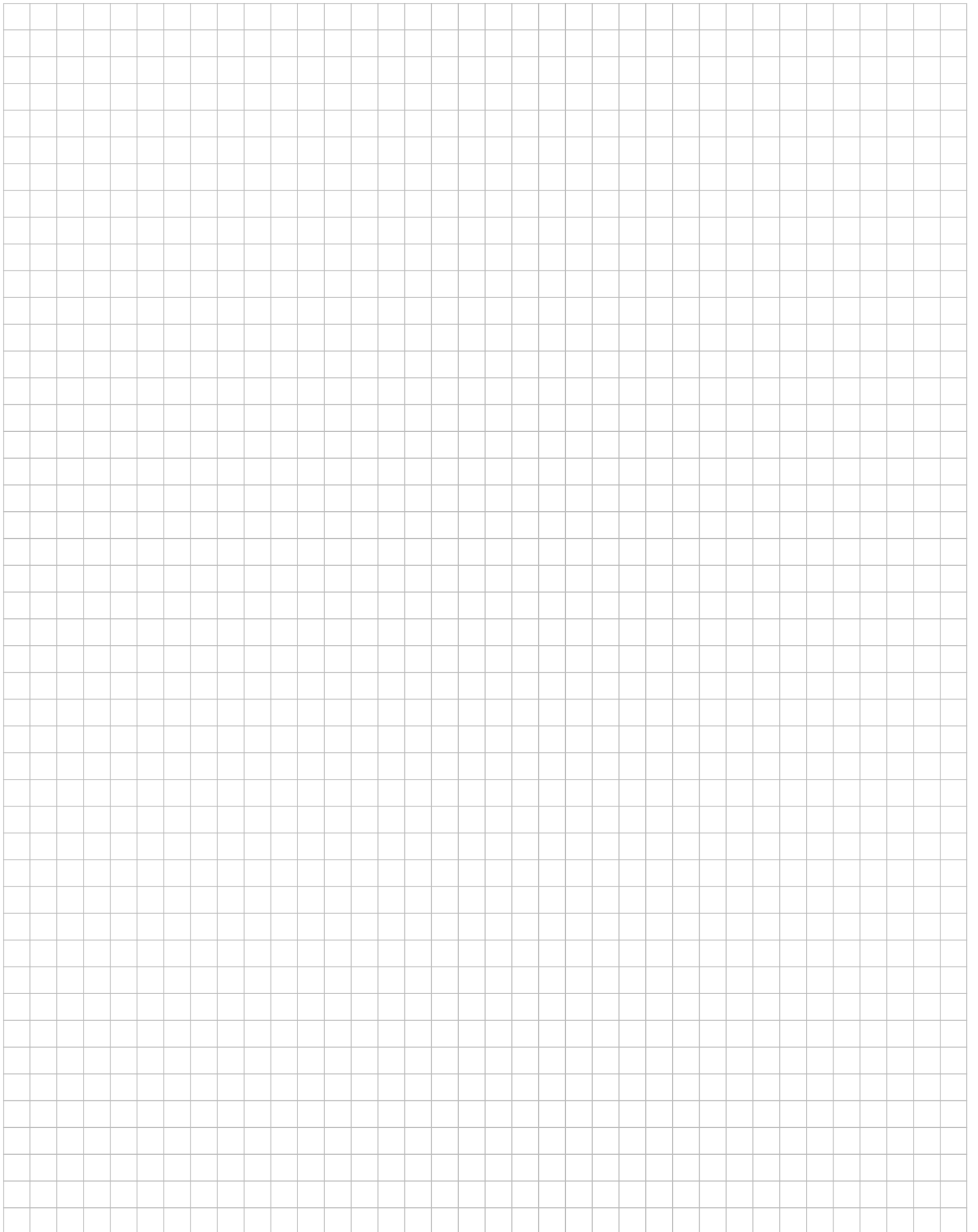

## We support PV systems



### Other K2 mounting systems

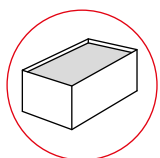

▶ Flat roof systems

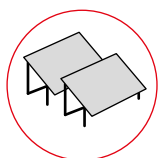

▶ Ground mounted systems

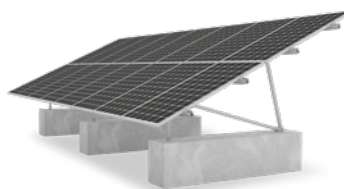

K2 Systems GmbH

Industriestraße 18  
71272 Renningen  
Germany

+49 7159 - 42059 - 0

info@k2-systems.com

www.k2-systems.com