

## GoodWe Global Sales & Service Network

### GoodWe (China)

No.189 Kunlunshan Rd., SND, Suzhou, 215163, China  
 T: +86 512 6239 6771  
 sales@goodwe.com  
 service.chn@goodwe.com

### GoodWe (Italy)

No. 17 Via Galimberti, Biella 13900, Italy  
 T: +39 (0) 15 4191921  
 sales@goodwe.com  
 service.it@goodwe.com

### GoodWe (India)

1202, G-Square Business Park, Sector 30A, Opp. Sanpada  
 Railway Stn., Vashi, Navi Mumbai- 400703  
 T: +91(0)9769 3475 60  
 sales@goodwe.com  
 service.in@goodwe.com

### GoodWe (Netherlands)

Franciscusdreef 42C, 3565AC Utrecht, the Netherlands  
 T: +31 (0) 30 737 1140  
 sales@goodwe.com  
 service.nl@goodwe.com

### GoodWe (Brazil)

Rua Abelardo 45, Recife/PE, 52050-310  
 T: +55 81 991239286  
 sergio@goodwe.com  
 servico.br@goodwe.com

### GoodWe (Portugal)

Fürstenrieder Str. 279a, 81377 München, Germany  
 T: +34 661 584870  
 sales@goodwe.com (Sales)  
 servico.pt@goodwe.com (Service)

### GoodWe (Korea)

8F Invest Korea Plaza, 7 Heoleung-ro Seocho-gu Seoul  
 Korea (06792)  
 T: +82 (2) 3497 1066  
 sales@goodwe.com  
 Larry.Kim@goodwe.com

### GoodWe (Germany)

Fuerstenriederstr. 279A, 81377 Munich  
 T: +49 (0) 800 998 1212  
 sales@goodwe.com  
 service.de@goodwe.com

### GoodWe (Australia)

Level 14, 380 St. Kilda Rd, Melbourne, VIC, 3004, Australia  
 T: +61 3 9324 0559  
 sales@goodwe.com  
 service.au@goodwe.com

### GoodWe (UK)

6 Dunhams Court, Dunhams Lane,  
 Letchworth Garden City, SG6 1WB UK  
 T: +44 (0) 333 358 3184  
 enquiries@goodwe.co.uk  
 service@goodwe.co.uk

### GoodWe (Turkey)

Adalet Mah. Megapol Tower K: 9 No: 110 Bayraklı - Izmir  
 T: +90 (232) 935 68 18  
 info@goodwe.com.tr  
 service@goodwe.com.tr

### GoodWe (Spain)

Fürstenrieder Str. 279a, 81377 München, Germany  
 T: +34 661 584870  
 sales@goodwe.com (Sales)  
 soporte.es@goodwe.com (Service)

### GoodWe (South Africa)

Fürstenrieder Str. 279a, 81377 München, Germany  
 T: +27 60 719 2956  
 sales.africa@goodwe.com (Sales)  
 service.africa@goodwe.com (Service)

### GoodWe (Mexico)

Oswaldo Sanchez Norte 3615, Col. Hidalgo, Monterrey,  
 Nuevo Leon, Mexico, C.P.64290  
 T: +52 1 81 2871 2871  
 sales@goodwe.com  
 soporte.ltam@goodwe.com

# GoodWe & BYD HV Battery Connection

For ET/EH/BT/BH Series + BYD HVM/HVS



Ver. 1.1

Updated on Jul 6th, 2020

www.goodwe.com

This is an instruction for quick installation of GoodWe HV series energy storage inverters (ARM version 11 or higher) and BYD-Box Premium HVM or HVS battery. For details of the connection or commissioning, please go to user manual of the inverter and the battery if you cannot find it in this instruction. Here we take GoodWe ET inverter and BYD Premium HVM battery as an example for connection and commissioning.

## Precautions

A

Make sure battery and inverter are not damaged and battery breaker is turned off before making any further move

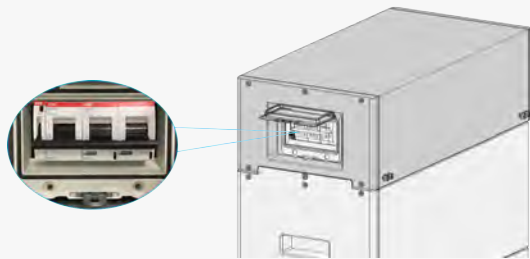

B

Loss the screws on battery control unit and move the cover plate to see all the connectors for battery

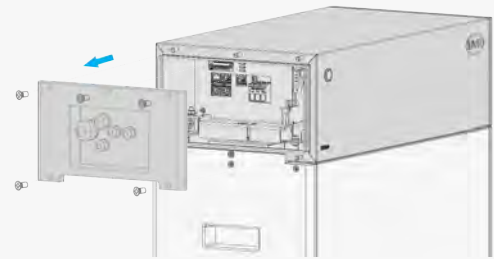

## Step 1: Power Cable Wiring

A

Put battery power cable through battery cover plate and press cable into the right port.

Power cable dimension: 4~6mm<sup>2</sup>

**Note: Please follow inverter's requirement to select power cable if there is conflict on ET and Battery manual**

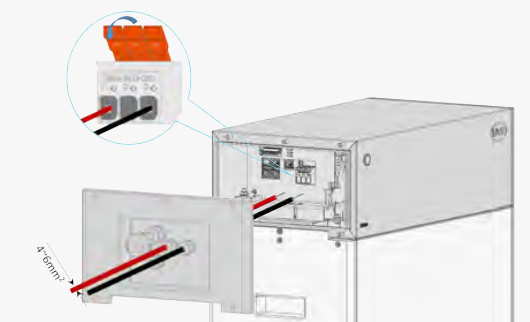

B

Connect other side of the power cable to inverter.

**Note: Please use the battery connectors in the components box of solar inverter**

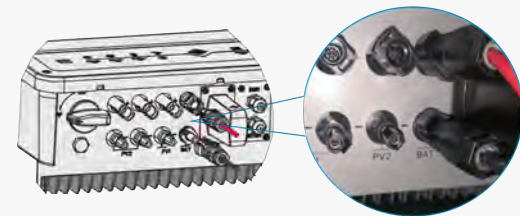

## Step 2: Communication Cable Wiring

On battery manual, there are various connection ways for communication or a general wiring system. Please follow this instruction for HVM or HVS communication with GoodWe inverters.

A. Cut off the preset BMS communication cable ("To Battery" cable) attached on inverter

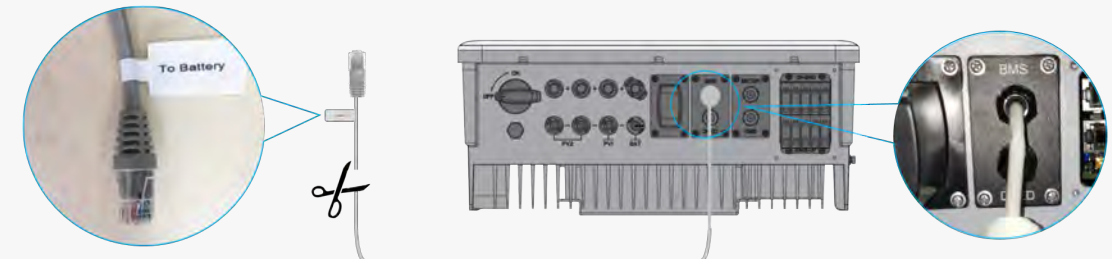

B. Split up pin cables inside the cable

**Note: Please use professional tools to do build up communication cable**

C. Connect CAN\_H (Blue) and CAN\_L (Blue & White) to port 1 and port 2

**Note: If you make a new CAT-5 cable to take place of or extend the preset BMS communication cable, please refer to Pin functions below**

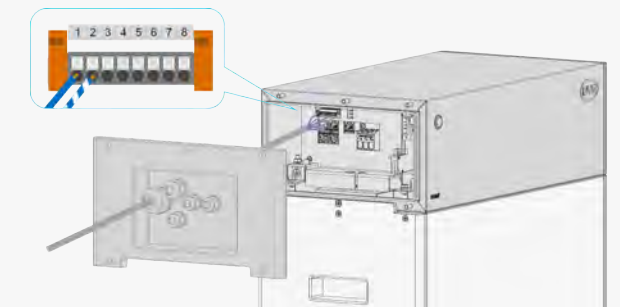

● Pin Function of BMS Communication Connector on Inverter Side



Position	Color	BMS Function
1	Orange&white	485_A2
2	Orange	NC
3	Green&white	485_B2
4	Blue	CAN_H
5	Blue&white	CAN_L
6	Green	NC
7	Brown&white	NC
8	Brown	NC

D. After power and communication cable installation, put the cover plate back properly. Then battery is ready to be started up before battery commissioning

## Step 3: Commissioning

NOTE: Commissioning is both required on battery and inverter.

- Battery Commissioning  
Use "Be Connect App" to do commissioning of battery (for details, please follow BYD Battery-Box Preium Firmware update & Configuration Guideline)



A Select "GOODWE HV" for inverter option

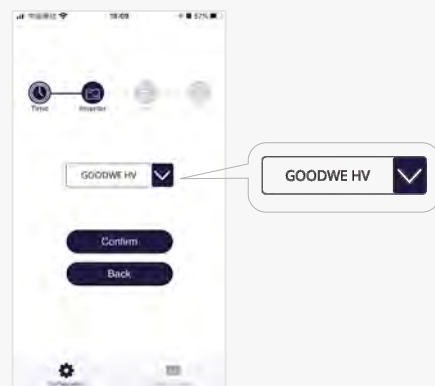

B Select HVM for battery option and set the realmodule No.

Note: for battery paralleling, the module no. is that of Master unit

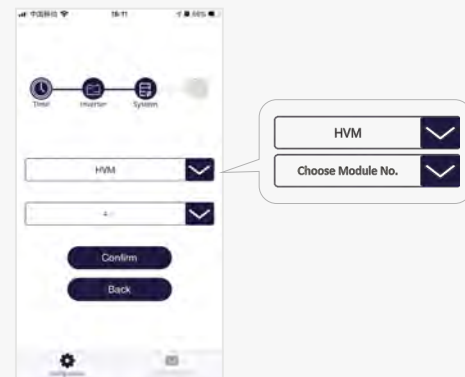

- Inverter Commissioning  
For detailed commissioning of the system on inverter, please follow GoodWe PV Master User Manual

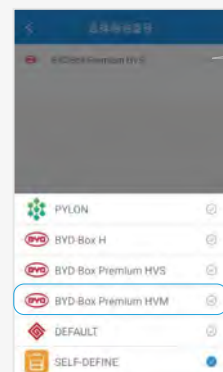

Click here to see all the compatible batteries with inverters

Note:  
wrong commissioning will cause BMS communication failure.

## Battery Paralleling:

For details, please follow BYD instructions.

- System Wiring Diagram

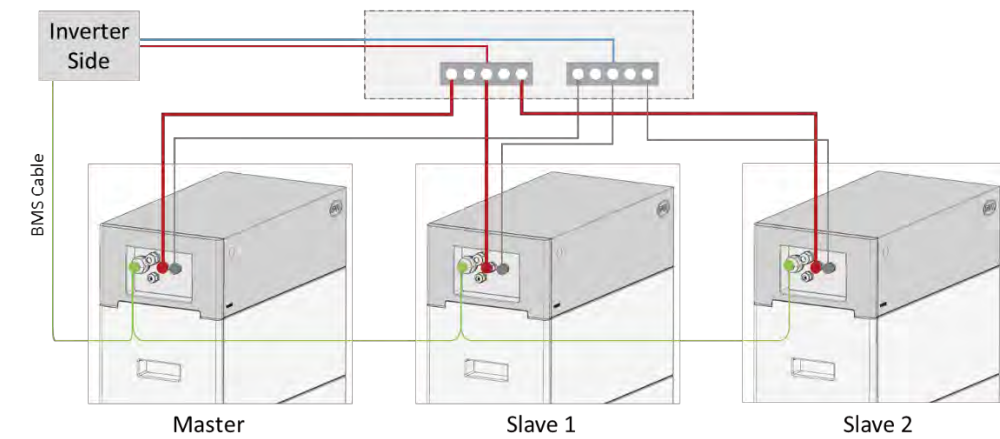

- Internal Communication Wiring (for BCU paralleling)
- Paralleling of 3 BCU

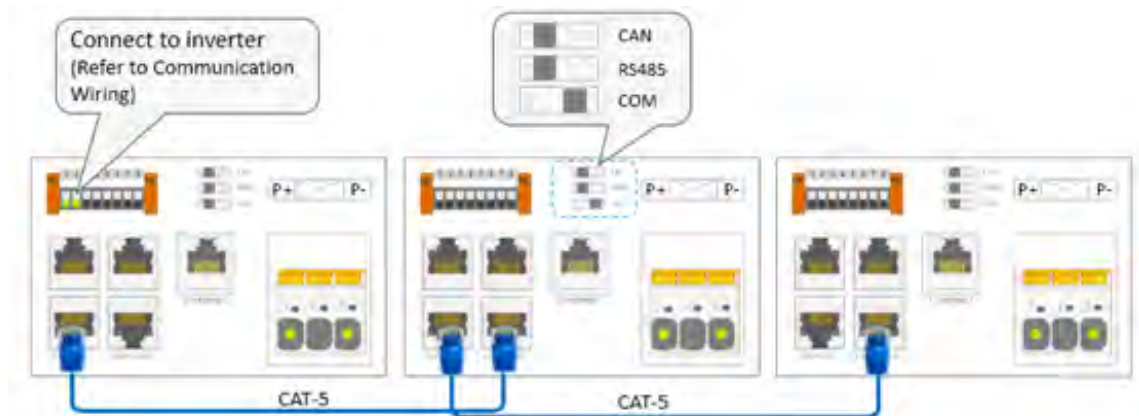

- Paralleling of 2 BCU

