

coolcept³-x

StecaGrid 3203x, StecaGrid 4003x, StecaGrid 4803x, StecaGrid 5503x

Inverter topology

The coolcept inverter topology was first implemented in the single-phase StecaGrid. It achieved optimum efficiency ratings thanks to the innovative switching concept. The three-phase coolcept³-x inverters also benefit from the advantages of this switching concept. The three-phase topology is fully reactive current capable and therefore set up to meet demands that may be made in future as well.

Always symmetrical

The advantage of three-phase feeding is that the produced solar capacity is always symmetrically distributed on all three power conductors to the public power grid. This is the case across the whole output range offered by these inverters. The symmetrical feed-in is very much in the interests of the power supply companies, and is also compatible with domestic three-phase consumption.

Highest efficiency with longer service life

The high efficiency results in a peak efficiency of 98.6 %, which means that less power is lost that must be dissipated into the environment. This improves your yields.

As at least two phases of a three-phase feed-in design feed energy into the grid, it is not necessary to provide for intermediate energy storage in the device, as must be done in the case of single-phase feed-in. For this reason, the coolcept³-x inverters dispense completely with the electrolytic capacitors that are required for intermediate storage. These capacitors may influence the service life of electronic devices as they may dry out. Therefore by using coolcept³-x inverters, plant operators may expect to benefit from their long service lives.

In addition to this, a new and unique cooling concept inside the inverter ensures an even distribution of the dissipated heat and a long service life for the device.

Product design and visualisation

The StecaGrid has a graphical LCD display for visualising the energy yield values, current performance and operating parameters of the system. Its innovative menu allows individual selection of the various measurements. The guided, pre-programmed menu allows easy final commissioning of the device.

Installation

The lightweight with only 12 kg can be easily and safely mounted on a wall. The supplied wall bracket make mounting of the device simple and convenient. The device does not need to be opened for installation. All connections and the DC circuit breaker are externally accessible. For making DC connections, Sunclix mating connectors are included in the scope of supply.

The devices meet all the standards for the IP65 protection class. Its robust stainless steel housing provides reliable protection against dust and water, including jet water. This enables problem-free installation of the inverters outdoors.

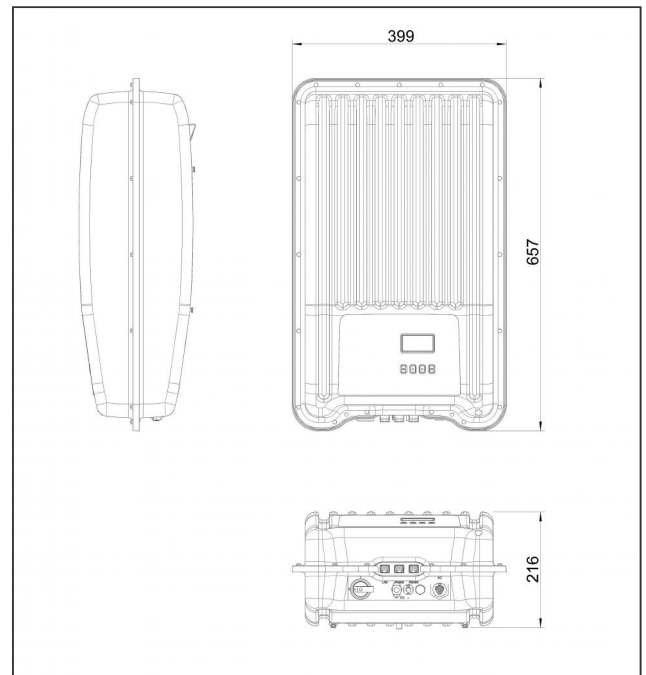

Product features

- Highest efficiency
- Three-phase, symmetrical grid feeding
- Simple installation
- Integrated data logger
- Low housing temperature at full load
- Solid stainless steel casing
- Suitable for outdoor installation
- Integrated DC circuit breaker
- Very long service life
- Droop Mode for integration in hybrid systems
- Fixed voltage mode for other energy sources
- Up to 7-year free warranty after registration
- Optimised shadow management using global MPP tracking

Displays

- Multifunction graphical LCD display with backlighting
- Animated representation of yield

Operation

- Simple menu-driven operation
- Multilingual menu navigation

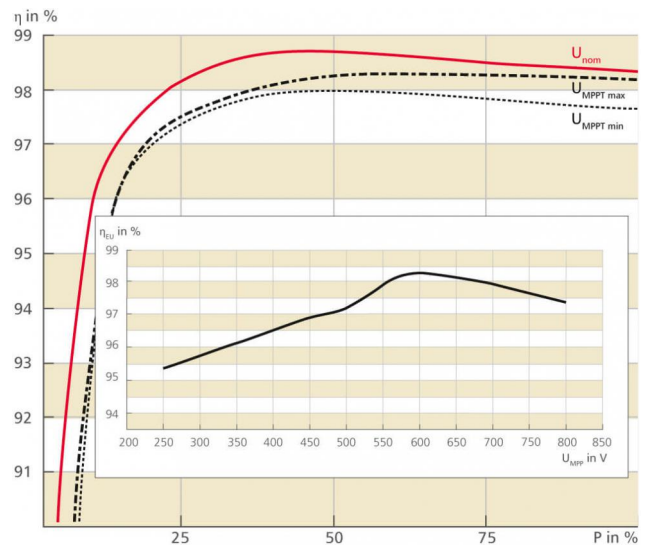

Efficiency values and comparison of the MPPT voltage of the StecaGrid 5503x



	StecaGrid 3203x	StecaGrid 4003x	StecaGrid 4803x	StecaGrid 5503x
DC input side (PV generator)				
Maximum input voltage	1000 V			
Operating input voltage range	250 V ... 800 V			
Number of MPP tracker	1			
Maximum input current	11.0 A			
Maximum short circuit current	+20 A / -13 A			
Maximum input power at maximum active output power	3300 W	4100 W	4920 W	5620 W
AC output side (Grid connection)				
Grid voltage	320 V ... 480 V (depending on regional settings)			
Rated grid voltage	400 V			
Maximum output current	7.0 A	7.0 A	10.0 A	10.0 A
Maximum active power (cos phi = 1)	3200 W	4000 W	4800 W	5500 W
Maximum active power (cos phi = 0.95)	3040 W	3800 W	4560 W	5225 W
Maximum active power (cos phi = 0.9)	2880 W	3600 W	4320 W	4950 W
Maximum apparent power (cos phi = 0.95)	3200 VA	4000 VA	4800 VA	5500 VA
Maximum apparent power (cos phi = 0.9)	3200 VA	4000 VA	4800 VA	5500 VA
Rated power	3200 W	4000 W	4800 W	5500 W
Rated frequency	50 Hz and 60 Hz			
Frequency	45 Hz ... 65 Hz (depending on regional settings)			
Night-time power loss	< 3 W W			
Feeding phases	three-phase			
Total harmonic distortion (cos phi = 1)	< 1 %			
Power factor cos phi	0.8 capacitive ... 0.8 inductive			
Characterisation of the operating performance				
Max. efficiency	98.6 %	98.6 %	98.7 %	98.7 %
European efficiency	97.9 %	98.1 %	98.2 %	98.3 %
Californian efficiency	98.3 %	98.4 %	98.5 %	98.5 %
MPP efficiency	> 99.8 % (static), > 99 % (dynamic)			
Own consumption	< 8 W			
Power derating at full power from	50 °C (T _{amb})	50 °C (T _{amb})	50 °C (T _{amb})	45 °C (T _{amb})
Safety				
Isolation principle	no galvanic isolation, transformerless			
Grid monitoring	yes, integrated			
Residual current monitoring	yes, integrated (The design of the inverter prevents it from causing DC leakage current)			
Operating conditions				
Area of application	indoor rooms with or without air conditioning, outdoors with or without protection			
Climate protection class as per IEC 60721-3-4	4K4H			
Ambient temperature	-15 °C ... +60 °C			
Storage temperature	-30 °C ... +70 °C			
Relative humidity	0 % ... 100 %, non-condensating			
Noise emission (typical)	29 dBA			
Fitting and construction				
Degree of protection	IP 65			
Overvoltage category	III (AC), II (DC)			
DC Input side connection	Phoenix Contact SUNCLIX (1 pair), mating connector included			
AC output side connection	Wieland RST25I5 plug, mating connector included			
Dimensions (X x Y x Z)	399 x 657 x 227 mm			
Weight	12.0 kg			
Communication interface	RS-485 (2 x RJ45 sockets; connectable to Meteocontrol WEB'log or Solar-Log™), Ethernet interface (1 x RJ45)			
Integrated DC circuit breaker	yes, compliant with VDE 0100-712			
Cooling principle	temperature controlled fan, variable speed, internal (dustproof)			
Test certificate	see certificate download on the product page			

